

USER MANUAL

Top Mount, Bottom Mount
and Single Door models



Westinghouse

CONGRATULATIONS

Congratulations and thank you for choosing our refrigerator/freezer. We are sure you will find your new appliance a pleasure to use. Before you use the appliance, we recommend that you read through the relevant sections of this manual, which provides a description of your appliance and its functions.

To avoid the risks that are always present when you use an electric appliance, it is important that the appliance is installed correctly and that you read the safety instructions carefully to avoid misuse and hazards.

We recommend that you keep this instruction booklet for future reference and pass it on to any future owners.

After unpacking the appliance, please check it is not damaged. If in doubt, do not use the appliance but contact your local customer care centre.

CONDITIONS OF USE

This appliance is designed and intended to be used in normal domestic applications only.



TIPS AND INFORMATION

IMPORTANT – CHECK FOR ANY DAMAGES OR MARKS. If you find the refrigerator is damaged or marked, you must report it within 7 days if you wish to claim for damage/marks under the manufacturer's warranty. This does not affect your statutory rights.



ENVIRONMENTAL TIPS

INFORMATION ON DISPOSAL FOR USERS

- Most of the packing materials are recyclable. Please dispose of those materials through your local recycling depot or by placing them in appropriate collection containers.
- If you wish to discard this product, please contact your local authorities and ask for the correct method of disposal.
- Local authorities will have the latest information regarding safe disposal of the product.
- Incorrect disposal may expose the user to injury from sharp objects, flammable gases or cause environmental damage.
- Refrigerant gases within the unit should only be discharged by qualified persons. A licence may be required by your local authorities to discharge or reclaim the refrigerant gases. Incorrect discharge of gases may expose the user to injury from flammable gases or cause environmental damage.
- When you dispose of your old refrigerators or freezers remove any doors. Children can suffocate if they get trapped inside a discarded unit.

CONTENTS

Important safety instructions	3
Top mount refrigerator features	4
Bottom mount refrigerator features	5
Single door all refrigerator features	6
Single door all freezer features	7
Installing your new appliance	8
Ventilation around your appliance.	8
Installing your refrigerator	8
Initial start-up	9
Electronic display controls – electronic models	10
Controlling the temperature.	10
Changing the freezer temperature.	10
Changing the refrigerator temperature	10
Quick freeze function	10
Freezer temperature alarm	10
Door alarm.	10
Child Lock	10
Drinks chill timer	10
Energy efficiency	11
Normal mode.	11
Eco mode	11
Holiday mode.	11
Other features (electronic models only)	11
Manual (rotary) controls – manual models	12
Controlling the temperature.	12
Using your appliance.	13
Door storage bins.	13
Dairy compartment	13
Deli bin	13
Crisper bin	13
Storesafe™ lockable bins	13
SpillSafe™ glass shelves	14
Bottle Holder	14
Freezer Drawers	14
Twist Ice & Serve	15
Care and maintenance	15
Changing the light bulb	15
General information	16
Cleaning the appliance	16
Safety	16
Switching off your appliance	16
Troubleshooting	17
Notes	18
Warranty	19

IMPORTANT SAFETY INSTRUCTIONS

Please read the user manual carefully and store in a handy place for later reference.

The symbols you will see in this booklet have these meanings:



WARNING

This symbol indicates information concerning your personal safety



CAUTION

This symbol indicates information on how to avoid damaging the appliance



TIPS AND INFORMATION

This symbol indicates tips and information about use of the appliance



ENVIRONMENTAL TIPS

This symbol indicates tips and information about economical and ecological use of the appliance

Meanings of symbols used in this manual are shown below:



This symbol indicates never to do this



This symbol indicates always do this



WARNING

STABILITY FOOT

When your refrigerator is in place, wind down the stability foot to the floor to stabilise it. Lift the front of the refrigerator to take the weight off the stability foot, then turn it $\frac{1}{4}$ turn further to ensure firm contact with the floor. If you do move the refrigerator, remember to wind it back up, to allow the refrigerator to roll. Remember to reset it when reinstalling.

side view

Stabilising foot wound down

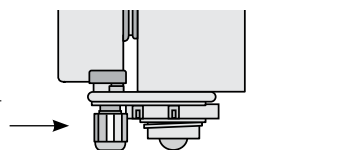

front view

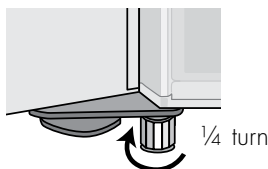

WARNING

- If pressurised aerosol containers bear the word 'flammable' and/or a small flame symbol, do not store them inside any refrigerator or freezer. If you do so you may cause an explosion.
- When you dispose of your old refrigerators and freezers, remove any doors. Children can suffocate if they get trapped inside.
- This appliance contains insulation formed with flammable blowing gases. Avoid safety hazards by carefully disposing of this appliance.



WARNING

- ✓ The refrigerator must be plugged into its own dedicated 220-240V, 50Hz AC electrical outlet.
- ✓ The plug must be accessible when the refrigerator is in position.
- ✓ It is essential the powerpoint is properly earthed to the ground. Consult a qualified electrician if you are unsure.
- ✗ Don't use extension cords or adapter plugs with this refrigerator.
- ✓ If the power cord is damaged, have it replaced by a qualified service technician.
- ✓ Unplug the refrigerator before cleaning it, or changing the light bulb to avoid electric shock.
- ✗ Never unplug the refrigerator by pulling the electrical cord as this may damage it. Grip the plug firmly and pull straight out.
- ✓ Choose a location for your refrigerator that isn't too cold. The ambient room temperature should be above 10°C.
- ✓ Stand your refrigerator in a dry place – avoid areas of high moisture or humidity.
- ✗ Don't put the refrigerator in frosty or unprotected areas like a garage or on the verandah.
- ✓ Keep the refrigerator out of direct sunlight.
- ✓ Don't locate the refrigerator near stoves, fires or heaters.
- ✓ When installed correctly, your refrigerator should:
 - Have adequate space at the back and sides for air circulation (refer to page 8).
 - Be aligned to the surrounding cupboards.
 - Have doors that will self-close from a partially open position.



WARNING

R600A REFRIGERANT WARNING

This appliance contains a small quantity of environmentally friendly, but flammable, non-synthetic R600a refrigerant. It does not damage the ozone layer. Avoid safety hazards by carefully installing, handling, servicing and disposing of this appliance. If your appliance contains R600a refrigerant it will be indicated on the rating plate inside the appliance:

- Ensure that the tubing of the refrigerant circuit is not damaged during transportation and installation.
- Leaking refrigerant may cause eye injuries or ignite.
- The room for installing appliance must be at least 1m³ per 8g of refrigerant. The amount of refrigerant in the appliance can be found on the rating plate inside the appliance.
- If you are unsure of the refrigerant check the rating plate inside the refrigerator compartment.
- It is hazardous for anyone other than an Authorised Service Person to service this appliance. In Queensland Australia the Authorisation Service Person MUST hold a Gas Work Authorisation for hydrocarbon refrigerants to carry out servicing or repairs which involve the removal of covers.

TOP MOUNT (TM) REFRIGERATOR FEATURES

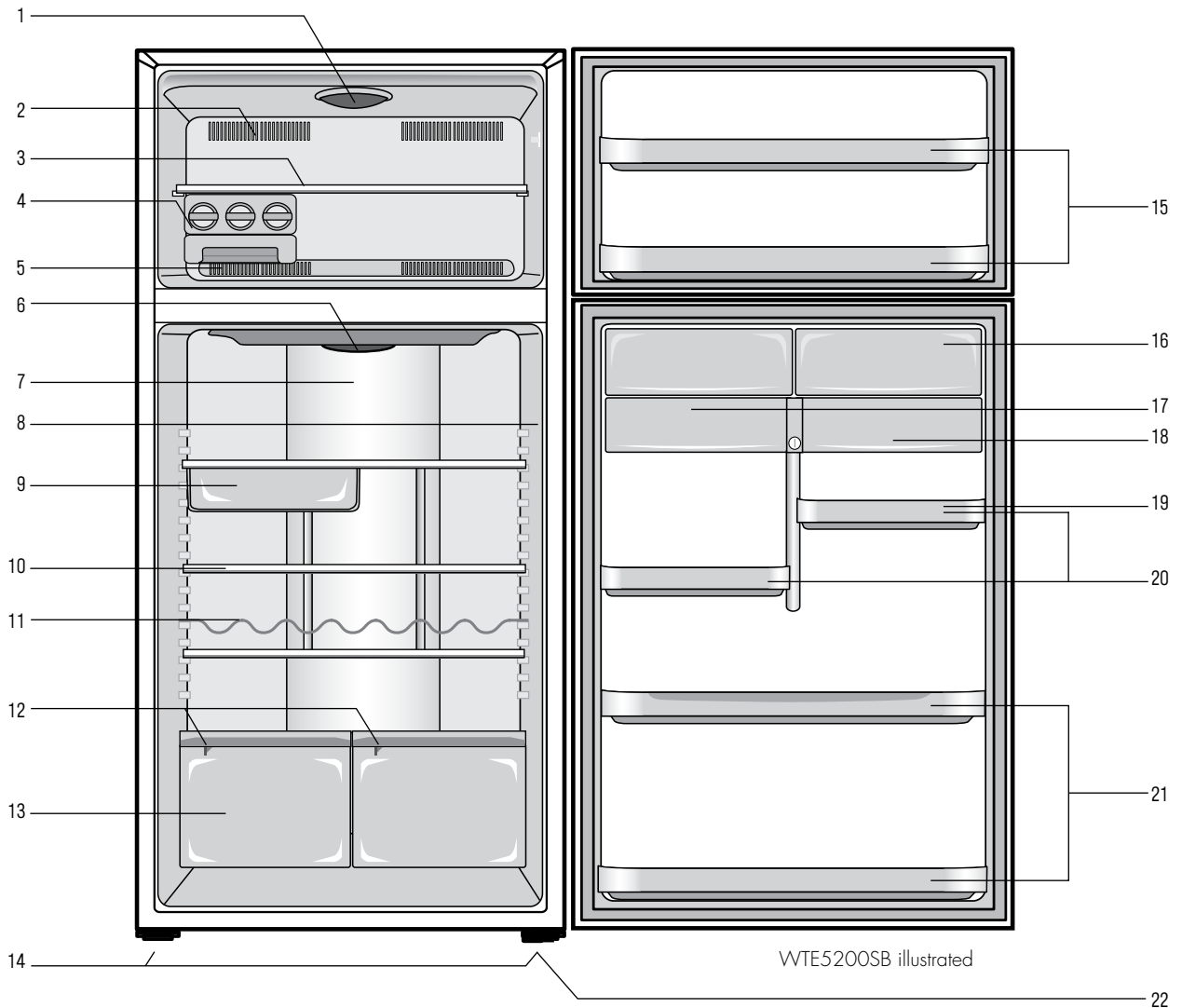

WTE5200SB illustrated

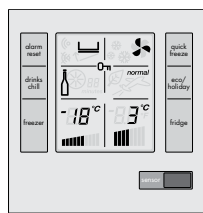

Electronic controls

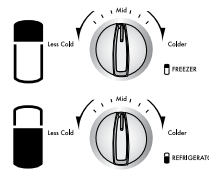

Manual controls

- | | | |
|---|---|------------------------------|
| 1 Freezer light (where fitted) | 8 Electronic temperature controls (where fitted, not illustrated) | 15 Freezer door bins |
| 2 Freezer air delivery vents | 9 Deli bin | 16 Twin dairy compartments |
| 3 Glass freezer shelf | 10 Adjustable glass shelves | 17 Storesafe™ bin (lockable) |
| 4 Twist & Serve ice cube tray and bin | 11 Bottle/wine rack | 18 Utility drawer |
| 5 Freezer air return vents | 12 Humidity controls | 19 Egg tray |
| 6 Refrigerator light | 13 Crisper bins on telescopic extension slides (where fitted) | 20 Adjustable door bins |
| 7 Manual temperature controls (where fitted, not illustrated) | 14 Adjustable rollers | 21 Bottle/can bins |
| | | 22 Stabilising foot |

Features may vary depending on model. Not all models will have features listed.

BOTTOM MOUNT (BM) REFRIGERATOR FEATURES

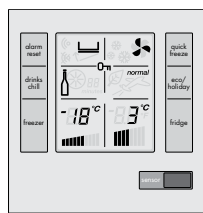
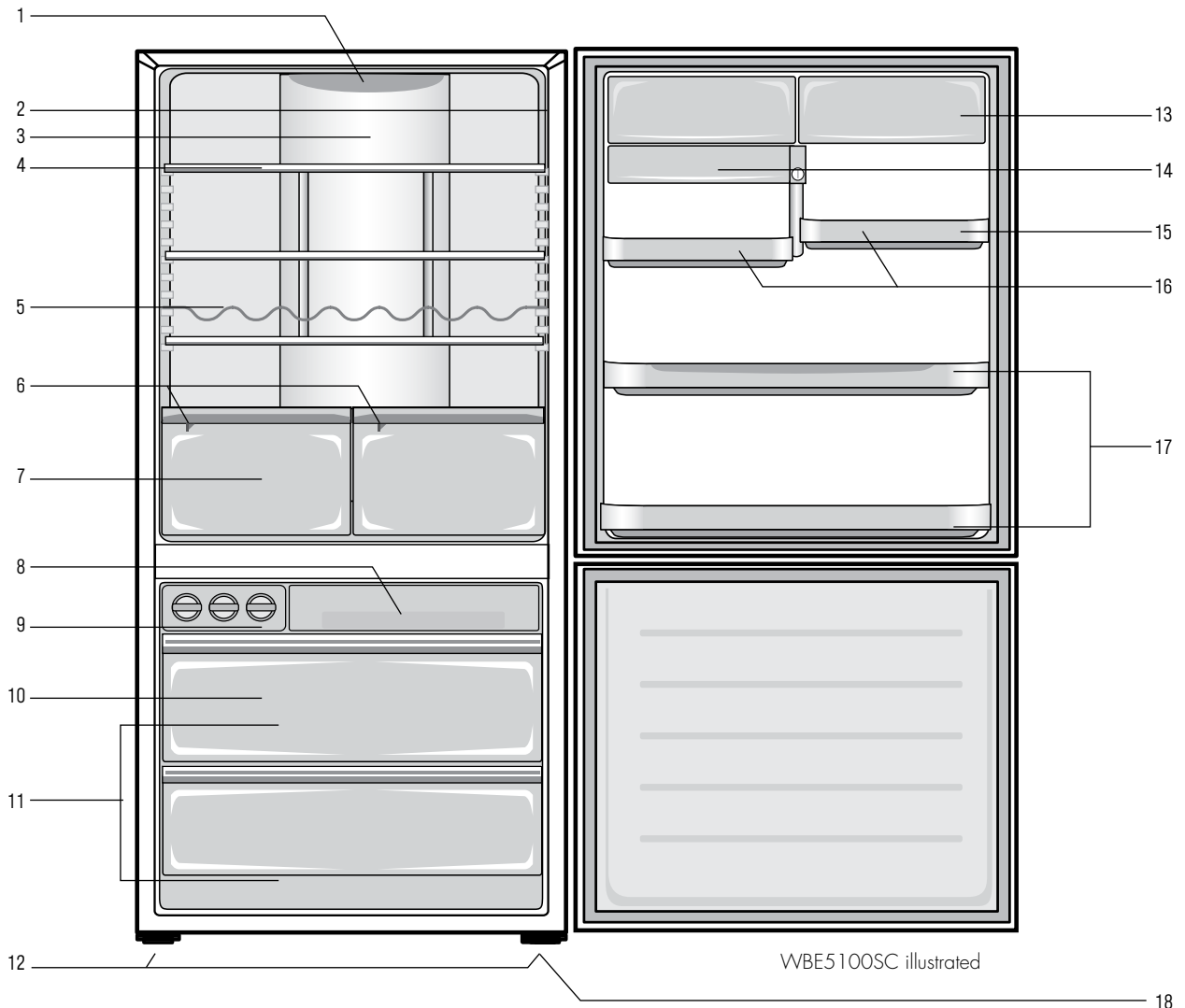

Electronic controls

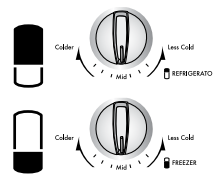

Manual controls

- | | | |
|---|--|------------------------------|
| 1 Refrigerator light | 7 Crisper bins on telescopic extension slides (where fitted) | 12 Adjustable rollers |
| 2 Electronic temperature controls (Where fitted. Not illustrated) | 8 Freezer storage tray | 13 Twin dairy compartments |
| 3 Manual temperature controls (Where fitted. Not illustrated) | 9 Twist & Serve ice cube tray | 14 Storesafe™ bin (lockable) |
| 4 Adjustable glass shelves | 10 Ice bucket and scoop (inside drawer, not illustrated) | 15 Egg tray |
| 5 Bottle/wine rack | 11 Freezer drawers on telescopic extension slides (where fitted) | 16 Adjustable door bins |
| 6 Humidity controls | | 17 Bottle/can bins |
| | | 18 Stabilising foot |

Features may vary depending on model. Not all models will have features listed.

SINGLE DOOR ALL REFRIGERATOR (AR) FEATURES

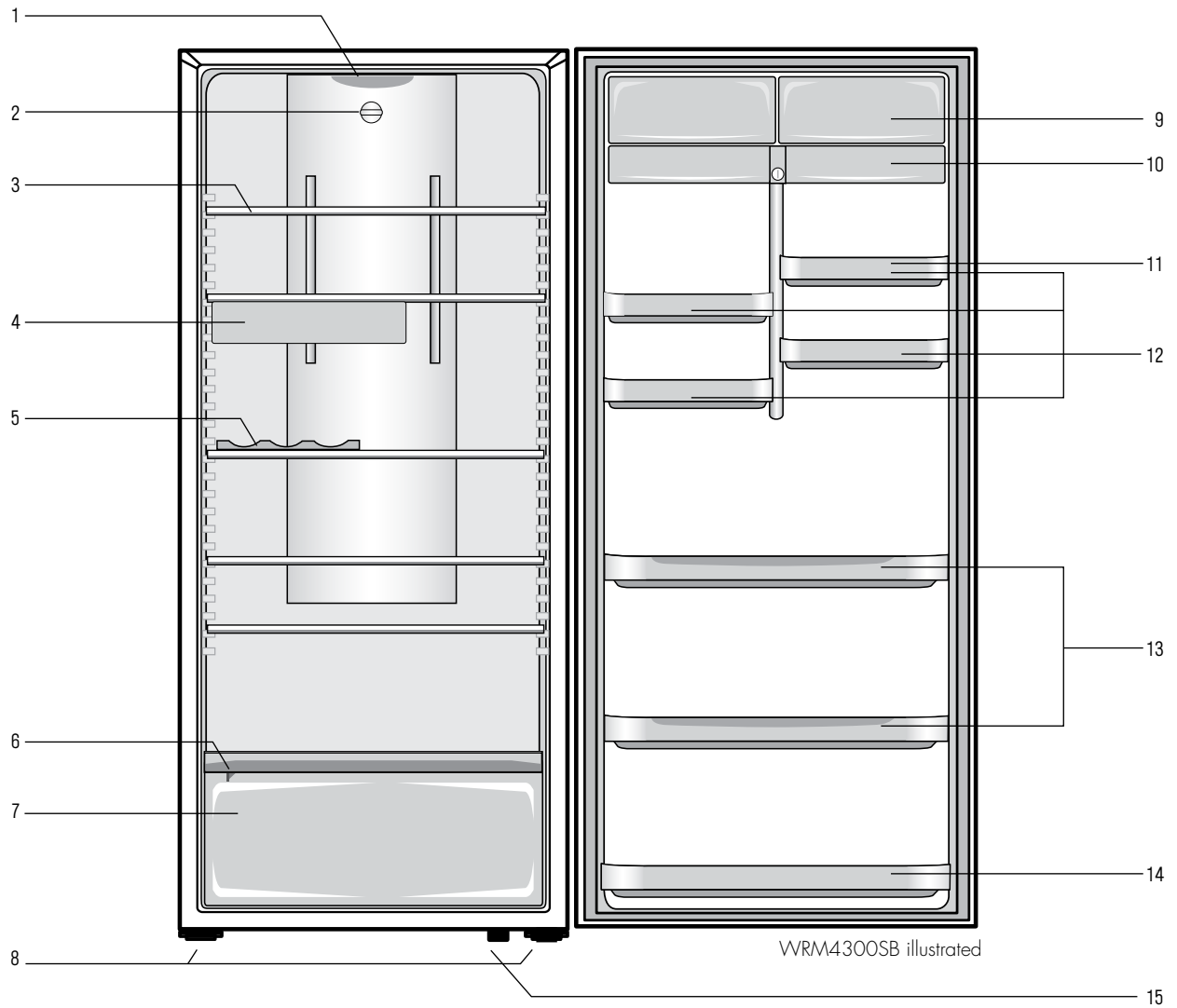

- | | | |
|----------------------------|--|-------------------------|
| 1 Refrigerator light | 7 Crisper bin on telescopic extension slides | 12 Adjustable door bins |
| 2 Temperature control | 8 Adjustable rollers | 13 Bottle bins |
| 3 Adjustable glass shelves | 9 Twin dairy compartments | 14 Can bin |
| 4 Deli bin | 10 Storesafe™ bin (lockable) | 15 Stabilising foot |
| 5 Bottle holder | 11 Egg tray | |
| 6 Humidity control | | |

Features may vary depending on model. Not all models will have features listed.

SINGLE DOOR ALL FREEZER (AF) FEATURES

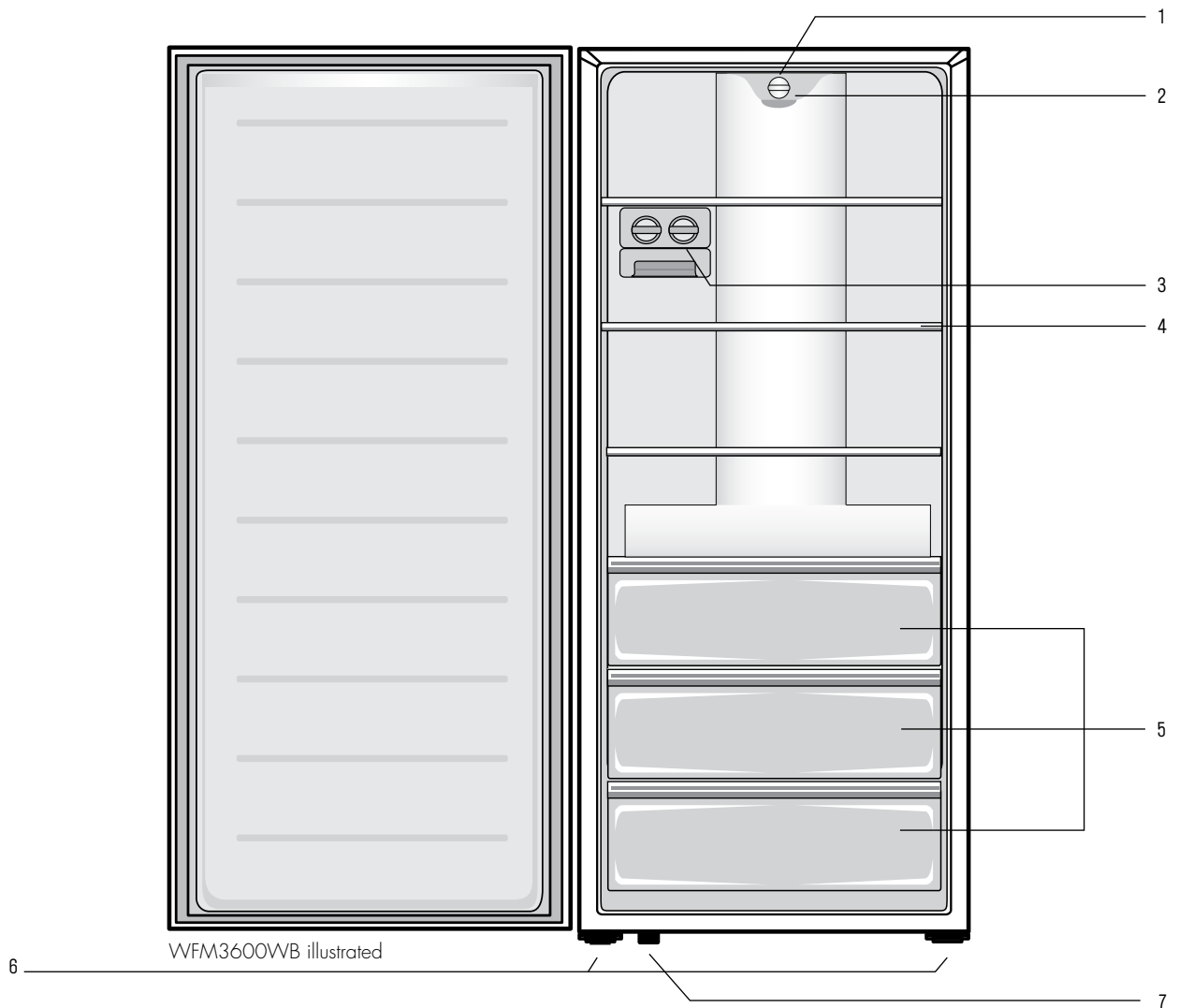

- | | | | | | |
|---|-------------------------------------|---|---|---|--------------------|
| 1 | Temperature control | 4 | Adjustable glass shelves | 6 | Adjustable rollers |
| 2 | Freezer light | 5 | Freezer bins on telescopic extension slides | 7 | Stabilising foot |
| 3 | Twist & Serve ice cube tray and bin | | | | |

Features may vary depending on model. Not all models will have features listed.

INSTALLING YOUR NEW APPLIANCE

ADEQUATE VENTILATION AROUND YOUR REFRIGERATOR.

The diagram below shows the recommended airspace to allow for ventilation of your refrigerator.

If you do not have a cupboard above the refrigerator with a rear gap of minimum 100 mm (Y), recommended clearance at the top of the refrigerator increases from 50mm to 90mm (X) minimum.

When positioned in a corner area, spacing of at least 350mm on the hinge side will allow the doors to open enough to enable the removal of bins and shelves.

Note: For those models with telescopic extension slide-out bins, the clearance required increases from 350mm to 550mm for top mount and bottom mount models, and to 450mm for the all refrigerator models to allow full access to the bins' contents as well as bin removal.

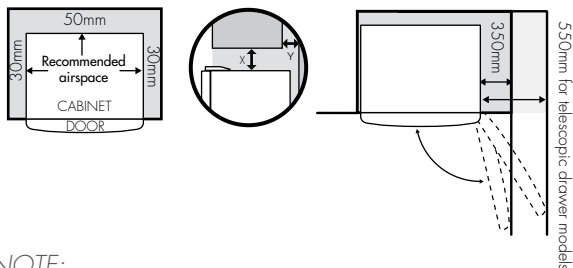

NOTE:

Doors are designed to sit proud of cabinetry (not flush). The clearances shown above are the recommended minimum clearances. The clearance at the rear must not exceed 75mm.

INSTALLING YOUR REFRIGERATOR

Your new refrigerator should arrive with the front adjustable rollers wound down, to tilt the top backwards by about 20mm from upright. This will allow your refrigerator door to self-close, providing a consistent closed seal.

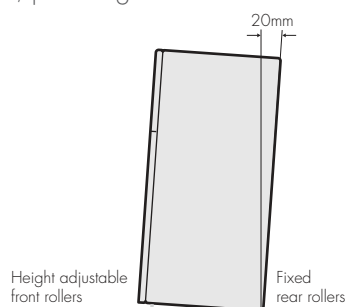

The stability foot should also be wound fully up so it will not interfere with the operation of the rollers (see diagram in Step 3).

WARNING

The rollers are designed for forward or backward movement only. They are not castors. Moving the refrigerator sideways may damage your floor and the rollers.

1. Roll the refrigerator into place.
2. The top of the refrigerator should be tilted back by 20mm (see diagram on left). This will allow the doors to self-close providing a consistent door seal.
3. If the refrigerator isn't tilted back, you can adjust the two front rollers by turning the large, plastic roller nut (see diagram below). One turn of the nut increases the height of the refrigerator by 10mm. If you have difficulty turning the roller nut, have someone tilt the refrigerator back, so you have better access. Alternatively, you can access the rollers from the side, using a flat screwdriver (see diagram below).

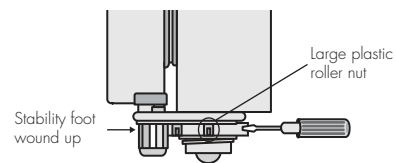

4. Check the alignment of the refrigerator to the surrounding cupboards to see if it is level. You can adjust the level with the rollers as detailed in step 3.

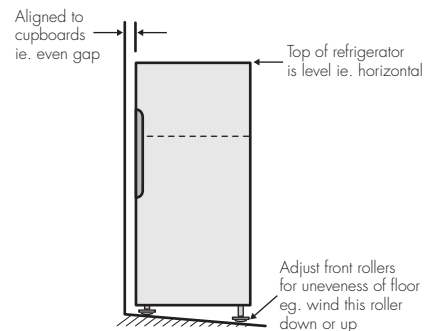

5. If you find your refrigerator rocks from corner to corner, it means your floor is uneven. Find a piece of plastic or hardboard etc. and pack it firmly under the roller.
6. On certain floor surfaces the refrigerator may roll forward during operation. Where provided a "Roller Stop" can be placed under the front rollers. If Roller Stop is required, contact customer service on 1300 363 640.

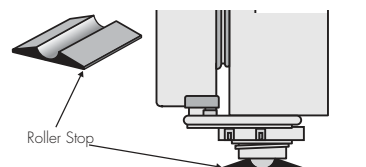

7. You may now need to fine-tune the installation by repeating Steps 3, 4 and 5.

- When you have the appliance in its final position, it needs to be stabilised. Wind the stability foot down to the floor until it just makes contact with the floor. Lift the front of the appliance to take the weight off the stability foot, then turn it $\frac{1}{4}$ turn further to ensure firm contact with the floor. Whenever you need to move the appliance, be sure to wind the foot back up so that the appliance can roll freely and be sure to reset it when reinstalling.

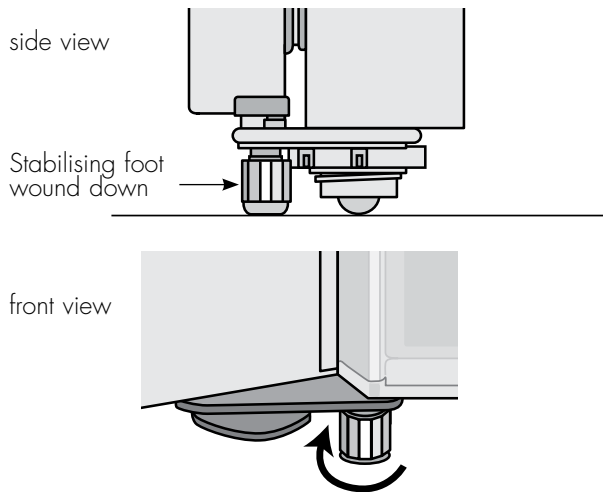

- Clean your refrigerator thoroughly following the instructions on page 16 and wipe off any dust that has accumulated during shipping.
- Plug your refrigerator straight into its own powerpoint and never use a double adapter. If you need to roll the refrigerator to get to the plug, remember to raise the stability foot first.
- Before you put any food in your refrigerator, it's recommended you leave it on for 2 or 3 hours to check it is running properly.

Congratulations! You have successfully installed your new refrigerator.

INITIAL START-UP

Refrigerators work by transferring heat from the food inside to the outside air. This operation makes the back and sides of the refrigerator (particularly at start-up) feel warm – which is normal.

A cooling coil is located behind the rear wall of the freezer section (in top mount, bottom mount and freezer models) and behind the crisper in the all-refrigerator models. This coil cools and removes moisture from the air inside.

Avoid placing food against the air vents in the refrigerator, as it affects the efficient circulation. If the door is opened frequently, a light frosting will occasionally occur on the freezer's interior. This is normal and will clear after a few days. If the freezer door is accidentally kept open, a heavy frost will coat the inside walls and should be removed.

Your new refrigerator uses a high-speed compressor, along with other energy-efficient components, which may make unusual sounds. These sounds simply indicate your refrigerator is working how it should. They include:

- Compressor running noises;
- Air movement noise from the small fan motor;
- A gurgling sound, similar to water boiling;
- A popping noise, heard during automatic defrosting; and
- A clicking noise, prior to compressor start-up.

Further details can be found on page 17.

i TIPS AND INFORMATION

- For top mount refrigerators. (where the freezer is on top of the fresh food compartment)
 - Don't place food forward of the ribs on the freezer floor, as it will keep the door open.

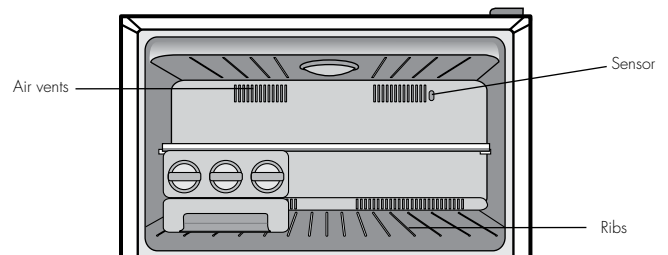

- For bottom mount refrigerators (where the freezer is below the fresh food compartment), single door refrigerators and single door vertical freezers
 - Ensure all freezer drawers and shelves are pushed back completely to prevent them from keeping the door open.

ELECTRONIC DISPLAY CONTROLS – ELECTRONIC MODELS

The LCD panel has a blue backlight and 6 touch buttons. It also contains an infrared light sensor, which turns the lights in the fresh food section on and off. When the power is first turned on, you will see the default settings, with the backlighting on.

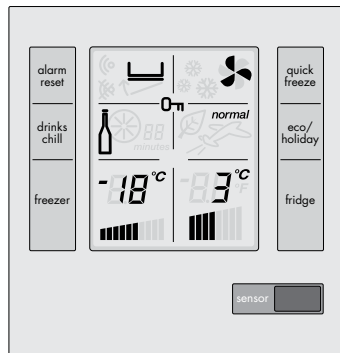

CONTROLLING THE TEMPERATURE

The default temperature for the refrigerator is 3°C and -18°C for the freezer. If you want to change the temperature, follow the instructions below. Make only small adjustments and wait 24 hours to see if it's correct. Checking the softness of ice cream is a good indication if your freezer is the right temperature, while checking the temperature of water kept in the refrigerator is a good way of checking the temperature of the food compartment.

NOTE:

When you set a temperature, you set an average temperature for the whole refrigerator cabinet. Temperatures inside each compartment may vary, depending on how much food you store and where you place it. High or low room temperature may also affect the actual temperature inside the refrigerator.

CHANGING THE FREEZER TEMPERATURE



Press the freezer button to make the freezer colder in 1°C steps. Once the maximum of -23°C is reached, the display will return to -14°C with the next press of the button. The bar graph gets smaller with colder freezer settings.

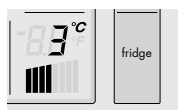

CHANGING THE REFRIGERATOR TEMPERATURE

Press the fridge button to make the refrigerator colder in 1°C steps. Once 0°C is reached, the display will return to 7°C with the next button press. The bar graph gets smaller with colder refrigerator settings.



QUICK FREEZE FUNCTION

Use the quick freeze function when you add a large amount of food to the freezer compartment. This freezes the food quickly but does not affect the temperature in the refrigerator compartment. To use this function, press the quick freeze button once. An animated icon will light up. The quick freeze function will now operate for 90 minutes. If you want to turn the quick freeze function off before 90 minutes have passed, simply press the quick freeze button again. The icon will disappear and the freezer will return to normal operation.

FREEZER TEMPERATURE ALARM



If the alarm sounds for no apparent reason, check whether anything is keeping the door open. If the freezer becomes too warm due to the freezer door being left open or warm food being placed too close to the temperature sensor, a buzzer will sound.

The icon adjacent to the alarm reset button, the freezer set temperature and bar graph will all flash, until the alarm reset button is pressed. Once pressed, the alarm disable icon adjacent to the alarm button will illuminate for 50 minutes, or until the temperature drops to an acceptable level.

Make sure nothing is holding the freezer door open and move any warm food away from the temperature sensor. If the freezer is still too warm after 50 minutes, the alarm will sound again, indicating that something may be wrong with the refrigerator.

NOTE:

The freezer temperature alarm can be reset for 12 hours by pressing the alarm reset button continuously for 10 seconds.



DOOR ALARM

If the fridge door is left open for more than two minutes, the alarm will buzz and an arrow pointing to an open door will flash, along with the temperature setting and bar graph.

If you want to leave the door open while you load the refrigerator, you can turn the alarm off for 8 minutes by pressing the alarm reset button.

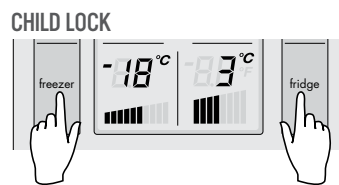

CHILD LOCK

Press and hold the freezer and fridge buttons together to activate the child lock. This will disable the display to prevent accidental changes to settings. To turn the child lock off, press and hold the freezer and fridge buttons together.

DRINKS CHILL TIMER



The drinks chill timer is used to quickly chill a bottle. Place the bottle in the freezer and the timer can be set for a minimum of 5 minutes to a maximum of 30 minutes. To set, simply press the drinks chill button repeatedly for the number of minutes (in 5-minute intervals). Once set, an animated icon appears beside the drinks chill button, with a timer that counts down one minute at a time.

You can change the time or turn the timer off even after the countdown has started. A buzzer will tell you when the time is finished and the icon will flash until the alarm reset button is pressed.

If your drink is not cold enough, reset the drinks chill function (remembering the drink is already partially chilled).

Suggested chilling times:

- 10 minutes for cans of drink
- 20 minutes for bottles of wine
- 30 minutes for bottles of soft drink



CAUTION

Care should be taken to ensure bottles are not left in freezer for longer periods as freezing and breakage could occur.

ENERGY EFFICIENCY

Your refrigerator has been designed to be energy-efficient and can operate in three modes: Normal, Eco and Holiday.

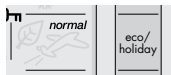

Normal mode

Normal mode is used when the refrigerator door is often opened. It's the default mode of your refrigerator.

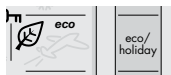

Eco mode

Eco mode can be used if you don't open your refrigerator door a lot. It is activated in one of two ways:

- by manually pressing the eco/holiday button once when in normal mode, or,
- by automatically activating after 30 hours if the refrigerator door has not been opened.

The leaf icon will appear on the electronic display when eco mode is on. If eco mode is activated automatically, the refrigerator will revert to normal mode once the refrigerator door is opened.

If eco mode is entered manually, opening the door will not revert it back to normal mode. To exit eco mode, simply press the eco/holiday button until the word "normal" is displayed.

Use Eco mode when you're not using the refrigerator all the time (eg. as a long-term storage refrigerator). If the door is going to be opened a lot, switch back to normal mode. Remember, if eco mode is turned on manually, it won't switch off automatically.



Holiday mode

Use this button when you go on holiday or leave the house for long periods.

The refrigerator minimises defrosting to save energy but maintains your temperature settings. To put the refrigerator into holiday mode, press the eco/holiday mode button until the aeroplane icon appears. The holiday mode will operate until the button is pressed again or the refrigerator door is opened.

NOTE:

Opening the freezer door won't effect the operation of either Eco or Holiday modes.

Eco and Holiday Modes minimise defrosting to save energy, while maintaining your temperature settings.

OTHER SPECIAL REFRIGERATOR FEATURES (ELECTRONIC MODELS ONLY)

- Independent control of the compressor and fan to provide the best performance.
- Extra cooling depending on the number of times the door is opened.
- Automatic defrost when the door is not frequently opened.
- 90-second memory display back-up to prevent the loss of settings during short power interruptions.
- Blue feature ramp-up lighting activated when the door is opened.

NOTE:

Display malfunctions may be due to brief power supply interruptions. If this occurs, turn the refrigerator off at the powerpoint and wait 5 minutes. The refrigerator pressure will need time to equalise before you turn the refrigerator on again.

MANUAL (ROTARY) CONTROLS – MANUAL MODELS

CONTROLLING THE TEMPERATURE

Only make small temperature adjustments at first and wait 24 hours to see if you need to make any more.

Top Mount Models

Use the temperature controls at the rear of the refrigerator compartment. Set refrigerator and freezer controls to MID at start-up.

- Adjusting the freezer temperature:
 1. Select the freezer control (top knob or left knob).
 2. Turn clockwise to set colder.
 3. Turn anti-clockwise to set less cold.

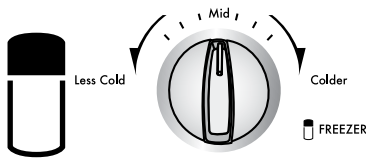

- Adjusting the refrigerator temperature:
 1. Select the refrigerator control (bottom knob or right knob).
 2. Turn clockwise to set colder.
 3. Turn anti-clockwise to set less cold.

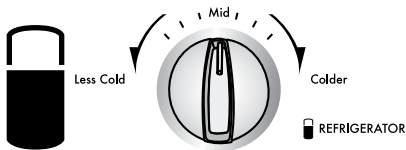

Bottom Mount Models

Use the temperature controls at the rear of the refrigerator compartment. Set refrigerator and freezer controls to MID at start-up.

- Adjusting the refrigerator temperature:
 1. Select the refrigerator control (top knob).
 2. Turn clockwise to set colder.
 3. Turn anti-clockwise to set less cold.

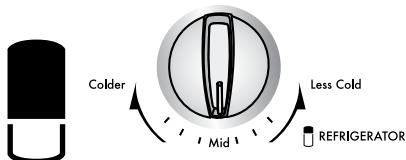

- Adjusting the freezer temperature:
 1. Select the freezer control (bottom knob).
 2. Turn clockwise to set colder.
 3. Turn anti-clockwise to set less cold.

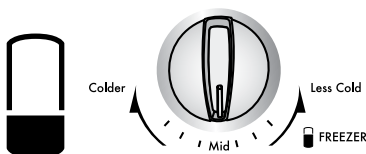

For top mount and bottom mount models, the coldest freezer setting is not recommended in normal or very hot climates. It will limit the cooling to the refrigerator section. In very cold climates (where temperatures are below 10°C) the freezer may need to be set colder.

Single Door All Refrigerator Models

Set the temperature with the temperature control at the rear of the compartment. Set refrigerator control to MID at start-up.

- Adjusting the all refrigerator temperature:
 1. Turn clockwise to set colder.
 2. Turn anti-clockwise to set less cold.



Single Door All Freezer Models

Use the temperature control at the top of the compartment. Set freezer control to MID at start-up.

- Adjusting the vertical freezer temperature:
 1. Turn clockwise to set colder.
 2. Turn anti-clockwise to set less cold.

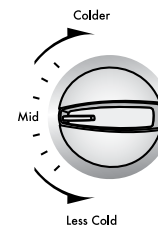

i TIPS AND INFORMATION

The thermostat in the temperature control is affected by altitude. It's recommended you set it warmer to compensate – eg. at 1000 metres above sea level, set the temperature control to one setting warmer than MID.

Checking the softness of ice cream is a good way to check the temperature of the freezer. Also, checking the temperature of water is a good way to check the temperature of the food storage compartment.

USING YOUR APPLIANCE

This section tells you how to make the most of the many useful features - cleaning instructions can be found on page 16.

DOOR STORAGE BINS

The top mount models, bottom mount freezer model and all refrigerator models are fitted with door storage bins. These bins adjust to meet different storage needs. All the door bins are completely removable for cleaning. If you want to remove or adjust a bin, lift it over the support lugs on the inner door panel. To replace, push the bin down over the support lugs to lock it in place.

DAIRY COMPARTMENT

Use the dairy compartment to store foods like butter, margarine and cheeses. The compartment is slightly warmer than the rest of the refrigerator compartment, while the lid provides protection against odours.

DELI BIN (WHERE FITTED)

Use the deli bin to store foods like smallgoods, fresh or cooked meat and cheese, or as an additional crisper. The bin will help prevent strong food odours from creeping into the rest of the refrigerator. To remove the deli bin, pull it forward, then lift it up and pull it further forward.

CRISPER BIN

Use the crisper bin to store vegetables, fruit or smallgoods. Change the humidity by sliding the humidity control.

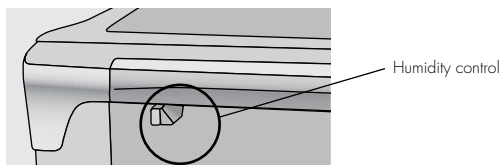

Storing vegetables

Store vegetables in the crisper bin and remember to set the humidity control to more humid (closed).

Storing fruit & smallgoods

Store fruit and smallgoods in the crisper bin and remember to set the humidity control to less humid (open).

Removal (standard Crisper Bins)

1. Empty food from the drawer.
2. Remove the crisper bin(s) by pulling forward, then up and forward again.
3. Remove the crisper shelf by lifting the catches on the underside of the shelf and pulling the shelf forward.

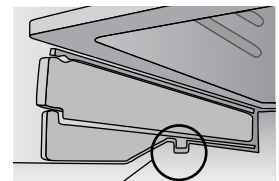

Removal – easy glide (on telescopic extension slides)

1. Remove the crisper bin(s) by pulling forward, then up and forward again, lifting the bin off the slides. Push the slides back into the refrigerator.

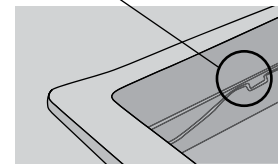

WARNING

Never close the door while the telescopic slides are extended. It may damage the slide and/or the refrigerator or cause the slide to become disengaged from the refrigerator.



CAUTION

To clean a crisper cover with telescopic extension slides, simply wipe with a damp cloth and warm soapy water. Never immerse the cover in water, as this could affect the operation of the slide.

To refit (see diagram on next page)

1. Make sure the runners are pushed in all the way.
2. Slide the bin into place over the telescopic slides and under the shelf. Push the bin in until it stops, noting that the bin will not be closed all the way.
3. Open the bin to access the finger tabs at the ends on each side of the bin. Use your thumb and forefinger to lift the bin over the end of the slide and clip in place.
4. Fully close the bin.

STORESAFE™ LOCKABLE BINS (WHERE FITTED)

These bins are designed to store items like cosmetics and medicines. They slide out for easy access. The left hand bin has a lock that is operated by turning the knob located on the fixed area between the bins. This may be turned with a coin. You can remove the Storesafe™ bin(s) for cleaning. Remove the bin by simply pulling past the stop in the runners. You will need to lift the bin while pulling it forward. A small amount of force may be required to overcome the front stop.



CAUTION

Never store solvents or flammable materials like nail polish remover or lighter fluid inside your refrigerator. They will affect the life of the plastic components and may taint stored food.

SPILLSAFE™ GLASS SHELVES (WHERE FITTED)

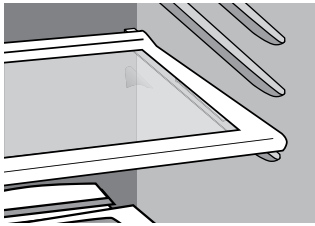

Spillsafe™ glass shelves keep spills on the shelf. A shelf retaining system minimises accidental movement of shelves and they can be adjusted to various heights. Spillsafe™ glass shelves are not to be used as slide out shelves. To remove the shelves, gently pull them forward until the shelf comes clear of the shelf guides. To return the shelf, make sure there is nothing behind that may obstruct movement. Gently push the shelf into the cabinet and back into position.

BOTTLE HOLDER

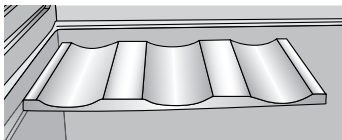

The bottle holder can be used to store various types of bottles like wine or beer. Bottles should be stored with the bottom end towards the back of the refrigerator. Selected models are supplied with a chrome, full-width wine rack.

FREEZER DRAWERS



Freezer drawers are fitted to bottom mount models and single door all freezer models. The drawers are mounted on telescopic extension slides, to enable full access to the content in the drawer. Clear plastic fronts provide easy visibility of foods.

To remove the drawer for cleaning.

1. Empty food from the drawer.
2. Remove the drawer by pulling it forward and lifting the front to unhook it from the slides. Once you have removed the drawer, ensure the slides are pushed back so they are fully closed.



WARNING

Never close the door while the telescopic slides are extended. This may damage the slide and/or refrigerator or cause the slide to become disengaged from the refrigerator.

To replace the drawer.

1. Make sure the telescopic slides are pushed in all the way.
2. Slide the drawer into place over the slides and push the bin in until it stops. The bin will not be closed all the way.
3. Open the bin to access the finger tabs at the ends of the telescopic slides, on each side of the bin. Using your thumb and forefinger, lift the bin over the end of the slide and clip in place. If the drawer is not fully engaged on the slide, it's possible the drawer won't stay on the slide if fully extended.

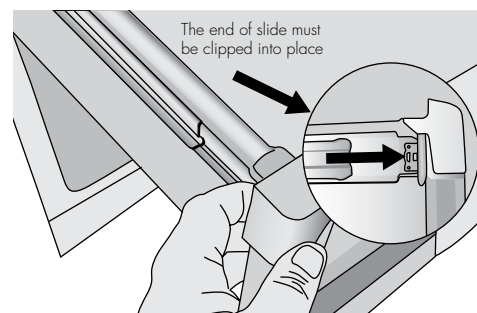

4. Fully close the bin.

When replacing the drawers after cleaning, we recommend fitting the lower drawer first.

TWIST ICE & SERVE (where fitted)

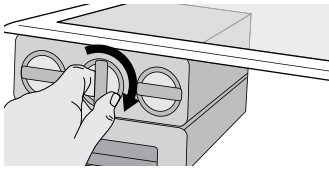

Some top mount, bottom mount and single door vertical freezer models have a twist ice & serve ice cube tray assembly. To use, remove the tray, fill with water and place back in the freezer. Once ice has formed (approximately 3 hours) simply twist the knob at the front clockwise until the ice drops into the bin below. A larger bin is provided in some bottom mount models along with an ice scoop.

Mounting the Twist Serve to the Other Side of the Freezer.

Note: this is only possible on Top Mount models.

1. Remove the ice bin and ice cube tray. If the ice tray assembly is frozen to the carriage, simply squeeze the tray and shelf together to break the ice.
2. Before you remove the ice carriage, remember to disengage it from the glass shelf (as shown), as it may result in damage to the assembly.
3. Remove the centre runner by disengaging it at the front of the shelf, and removing it from the rear.
4. Refit the runner in to the rear of the shelf on the right hand side and then engage the front (as shown).
5. Fit the carriage by sliding it into the runners until the front of the carriage engages with the shelf.
6. Refit the ice tray and ice bin.

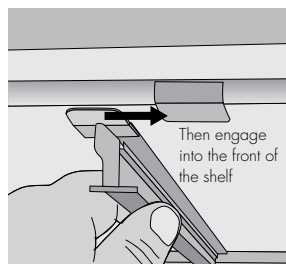
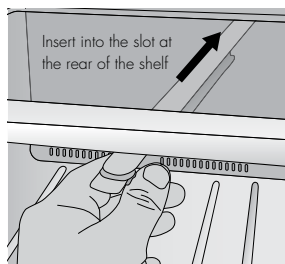
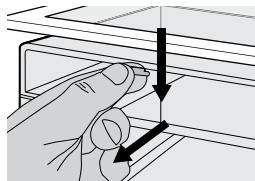

5. Fit the carriage by sliding it into the runners until the front of the carriage engages with the shelf.
6. Refit the ice tray and ice bin.

CARE AND MAINTENANCE

CHANGING THE LIGHT BULB

Refrigerator Light

1. Switch off the power at the powerpoint and remove the cord by pulling the plug.
2. Carefully unclip the light cover as shown in the pictures.

greater than 350litre

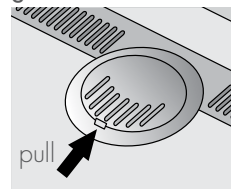

less than 350litre

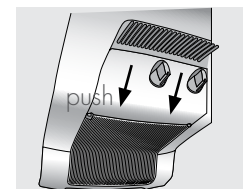

3. Unscrew the light bulb and replace it with a new bulb of the same type and wattage. If, when you remove the light bulb the small rubber "O" ring comes out with the bulb, fit the "O" ring over the new bulb and screw bulb into the socket (see diagram at bottom of page).
- ⚠ Never insert your finger into the light bulb socket to check for the presence of the "O" ring.**
4. Replace the light cover by hooking the lugs into the slots and pressing up until it clips in.
 5. Wait 5 minutes to ensure pressures in the refrigeration system are equalised, before turning the refrigerator on at the powerpoint.

Freezer light (where fitted)

1. Switch off the power at the powerpoint and remove the cord by pulling the plug.
2. Carefully unclip the light cover by pulling the light cover tab at the rear, towards you.
3. Unscrew the light bulb and replace it with a new one of the same type and wattage. If, when you remove the light bulb the small rubber "O" ring comes out with the bulb, fit the "O" ring over the new bulb and screw bulb into the socket (see diagram at bottom of page).

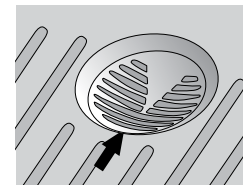

⚠ Never insert your finger into the light bulb socket to check for the presence of the "O" ring.

4. Replace the light cover by hooking the light cover lugs into the front of the housing and pressing the rear of the cover up until it clips in.
5. Wait 5 minutes to ensure pressures in the refrigeration system are equalised before turning the refrigerator on at the powerpoint.

i TIPS AND INFORMATION

Ensure the 'O' ring is in place before replacing the bulb.

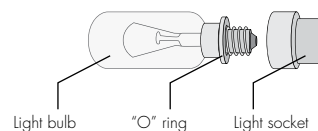

GENERAL INFORMATION

CLEANING THE REFRIGERATOR



WARNING

BEFORE CLEANING: Turn the refrigerator off at the powerpoint and unplug the cord to prevent any chance of electrocuting yourself.

- **Doors and exterior (white & pacific silver)**
You should only clean the doors with lukewarm soapy water and a soft cloth.
- **Stainless Steel**
Your stainless steel refrigerator is manufactured from mark-resistant stainless steel. This stainless steel has a special advanced protective coating that eases the removal of marks such as fingerprints and water spots. To keep its appearance, clean it regularly with lukewarm soapy water and a soft cloth.



CAUTION

Never use stainless steel cleaners, abrasive pads or other cleaners that will scratch the surface. Damage to the appliance after delivery is not covered by your warranty.

- **Interior**
Clean the inside of your refrigerator regularly with a soft cloth, unscented mild soap and lukewarm water. Thoroughly dry all surfaces and removable parts and avoid getting water on the controls. Replace removable parts, plug power cord in and switch the power on before returning the food.
- **Door seals**
Always keep door seals clean by washing them with a mild detergent and warm water, followed by a thorough drying. Sticky food and drink can cause seals to stick to the cabinet and tear when you open the door.



WARNING

Never use hot water, solvents, commercial kitchen cleaners, aerosol cleaners, metal polishes, caustic or abrasive cleaners, or scourers to clean your refrigerator. Many commercially available cleaning products and detergents contain solvents that will damage your refrigerator. Use only a soft cloth with an unscented mild soap and lukewarm water.

If your refrigerator has telescopic extension slides, simply wipe them with a damp cloth to clean them and never immerse them in water.

SAFETY

It is important to use your appliance safely. This means you need to supervise young children and infirm persons when they use it. You need to make sure that young children do not play with the appliance. Follow the tips below.

ALWAYS DO THIS

- ⓘ Check the powerpoint is properly earthed – if you are not sure get an electrician to check it.
- ⓘ Switch off and unplug the refrigerator at the powerpoint before you clean or move it.
- ⓘ If the power supply cord is damaged, have it replaced by the manufacturer, a service agent or similarly qualified person.

NEVER DO THIS

- ⓧ Never let children play with the refrigerator.
- ⓧ Never store spray cans, explosive fluids or flammable liquids in the refrigerator.
- ⓧ Never store fizzy drinks in the freezer compartment.
- ⓧ Never lick icy foods when they first come out of the freezer. This can burn your lips and mouth.
- ⓧ Never try to repair the refrigerator yourself.
- ⓧ Never use electric heaters or dryers to defrost the freezer because you can receive an electric shock.
- ⓧ Never use electrical appliances inside the food storage areas.
- ⓧ This appliance contains insulation formed with flammable blowing gases. For safety reasons, take care when you dispose of it.
- ⓧ Do not damage the appliance circuit.



WARNING

When you dispose of your old refrigerator or freezer, remove any doors to prevent children from being trapped inside.



WARNING

R600A REFRIGERANT WARNING

This appliance contains a small quantity of environmentally friendly, but flammable, non-synthetic R600a refrigerant. It does not damage the ozone layer. Avoid safety hazards by carefully installing, handling, servicing and disposing of this appliance. If your appliance contains R600a refrigerant it will be indicated on the rating plate inside the appliance:

- Ensure that the tubing of the refrigerant circuit is not damaged during transportation and installation.
- Leaking refrigerant may cause eye injuries or ignite.
- The room for installing appliance must be at least 1m³ per 8g of refrigerant. The amount of refrigerant in the appliance can be found on the rating plate inside the appliance.
- If you are unsure of the refrigerant check the rating plate inside the refrigerator compartment.
- It is hazardous for anyone other than an Authorised Service Person to service this appliance. In Queensland Australia the Authorisation Service Person MUST hold a Gas Work Authorisation for hydrocarbon refrigerants to carry out servicing or repairs which involve the removal of covers.

SWITCHING OFF YOUR REFRIGERATOR

If you switch off your refrigerator for an extended period, follow these steps to reduce the chances of mould:

1. Remove all food.
2. Remove the power plug from the powerpoint.
3. Thoroughly clean and dry the interior.
4. Ensure that all the doors are wedged open slightly for air circulation.

TROUBLESHOOTING

PROBLEM	SOLUTION
Refrigerator is not operating	<ul style="list-style-type: none"> • Check that the power cord is plugged into the power outlet properly and that the outlet is switched 'ON'. • Try running another appliance from the power outlet. If no power is coming from the outlet you may have blown a fuse or tripped a circuit of your household power supply. • Try adjusting the temperature control to a slightly "colder" position. • It is normal for the freezer fan NOT to operate during the automatic defrost cycle, or for a short time after the appliance is switched on.
When there is refrigerator/freezer noise	<p>Modern refrigerators/freezers with increased storage capacity use high speed compressors. These can provide a seemingly high level of sound which is quite normal. Normal operational sounds include:</p> <ul style="list-style-type: none"> • Occasional gurgling, similar to water boiling. • Air flow noise (air circulates because of a small fan). • A popping noise heard during automatic defrost. • A clicking noise heard just before the compressor starts (this is just the automatic switching action of the temperature control, turning the compressor on or off). <p>Other strange sounds may mean that you need to check and take action. For example, noises may mean that:</p> <ul style="list-style-type: none"> • The cabinet is not level. • The floor is uneven or weak. • Bottles are badly placed and rattling. • There are vibrations from an object on top of or behind or beside the refrigerator. • The back of the refrigerator cabinet is touching the wall. <p>Remember it is quite normal for noise to seem louder when the refrigerator starts operating, or during quieter periods such as night time.</p>
It is normal for the freezer door to momentarily open and re-close when the food compartment door is closed	<p>If the freezer door stays open, it indicates that the refrigerator cabinet needs to be tilted backwards a little further. If you call a service person to solve this problem, you will be charged for the cost of a service call, as this is not a warranty fault.</p>
If there are odours inside the refrigerator	<ul style="list-style-type: none"> • The interior may need cleaning. • Some foods produce odours. • Some containers and wrapping can cause odours. • Ask yourself if the odour started about the same time you started storing something unusual.

PROBLEM	SOLUTION
When the motor seems to run more than expected	<p>Your new refrigerator has a large fridge and freezer section to keep cool. So it is normal to frequently hear the sound of the motor. However, to keep operation to a minimum check the following:</p> <ul style="list-style-type: none"> • Are doors kept open too long or too often? • Are controls set too cold? See 'Controlling the temperature' on pages 10–12. • Have large amounts of warm food just recently been stored? Summer, festive seasons and holidays usually mean a lot more work for your refrigerator. • If the day is hot or the room is very warm, the refrigerator will need to run more than normal. • The refrigerator will run more than normal just after you install it or when it has been turned off for a long time.
If the temperature in the refrigerator is too warm	<ul style="list-style-type: none"> • Check that the appliance has enough clearance at the sides, back and top. Refer to the installation instructions on page 8. • Refer to 'Controlling the temperature' on pages 10–12. • You may have kept the door open too long or too frequently. • Food containers or packaging may be holding a door open.
If the temperature in the refrigerator is too cold	<ul style="list-style-type: none"> • Refer to 'Controlling the temperature' on pages 10–12. • Increase the temperature to avoid high energy consumption.
If heavy frosting occurs in the freezer	<p>Make sure you fully close the freezer and fridge doors. If the doors are left open, a heavy frost will coat the inside of the freezer. If a frost develops, remove it and take care to properly close the doors.</p>
If water drips on the floor	<p>The defrost water tray (located at the back or underneath of the cabinet) may not be properly positioned, or the drain tube may not be properly positioned to direct water into this tray. You may need to pull the refrigerator away from the wall to check the tray and tube.</p>
Fridge does not exit vacation mode	<p>Turn appliance off at the powerpoint. Leave off for three (3) minutes for the memory to clear, then turn back on.</p>
When temperature is hot/warm on the outside and rear side of the Fridge	<p>In normal operation, the fridge transfers heat from inside to outside of the cabinet. It is normal for the side and rear of the fridge to feel warm/hot while operating. This will be more noticeable during start up and hot ambient conditions.</p>

IF YOU STILL REQUIRE SERVICE

If you have a problem, and the problem persists after you have made the checks mentioned above, contact your nearest approved Service Centre or the dealer you bought the refrigerator from. Be ready to quote the model number, 9-digit PNC and 8-digit serial number, which is stated on the label inside the refrigerator compartment.

NOTES

Lined writing area for notes.

This document sets out the terms and conditions of the product warranties for Electrolux Appliances. It is an important document. Please keep it with your proof of purchase documents in a safe place for future reference should you require service for your Appliance.

1. In this warranty:
 - (a) 'acceptable quality' as referred to in clause 10 of this warranty has the same meaning referred to in the ACL;
 - (b) 'ACL' means Schedule 2 to the Competition and Consumer Act 2010;
 - (c) 'Appliance' means any Electrolux product purchased by you and accompanied by this document;
 - (d) 'ASC' means Electrolux authorised service centres;
 - (e) 'Electrolux' means Electrolux Home Products Pty Ltd of 163 O'Riordan Street, Mascot NSW 2020, ABN 51 004 762 341 in respect of Appliances purchased in Australia and Electrolux (NZ) Limited (collectively 'Electrolux') of 3-5 Niall Burgess Road, Mount Wellington, in respect of Appliances purchased in New Zealand;
 - (f) 'major failure' as referred to in clause 10 of this warranty has the same meaning referred to in the ACL and includes a situation when an Appliance cannot be repaired or it is uneconomic for Electrolux, at its discretion, to repair an Appliance during the Warranty Period;
 - (g) 'Warranty Period' means the Appliance is warranted against manufacturing defects in Australia and New Zealand for 24 months and for the Appliance's compressor, condenser, evaporator and drier, an additional 36 months parts only warranty applies, following the date of original purchase of the Appliance;
 - (h) 'you' means the purchaser of the Appliance not having purchased the Appliance for re-sale, and 'your' has a corresponding meaning.
2. This warranty only applies to Appliances purchased and used in Australia or New Zealand and used in normal domestic applications and is in addition to (and does not exclude, restrict, or modify in any way) any non-excludable statutory warranties in Australia or New Zealand.
3. During the Warranty Period Electrolux or its ASC will, at no extra charge if your Appliance is readily accessible for service, without special equipment and subject to these terms and conditions, repair or replace any parts which it considers to be defective. Electrolux or its ASC may use remanufactured parts to repair your Appliance. You agree that any replaced Appliances or parts become the property of Electrolux. This warranty does not apply to light globes, batteries, filters or similar perishable parts.
4. Parts and Appliances not supplied by Electrolux are not covered by this warranty.
5. To the extent permitted by law, you will bear the cost of transportation, travel and delivery of the Appliance to and from Electrolux or its ASC. If you reside outside of the service area, you will bear the cost of:
 - (a) travel of an authorised representative;
 - (b) transportation and delivery of the Appliance to and from Electrolux or its ASC.

In all instances, unless the Appliance is transported by Electrolux or an Electrolux authorised representative, the Appliance is transported at the owner's cost and risk while in transit to and from Electrolux or its ASC.
6. Proof of purchase is required before you can make a claim under this warranty.
7. You may not make a claim under this warranty unless the defect claimed is due to faulty or defective parts or workmanship. Electrolux is not liable in the following situations (which are not exhaustive):
 - (a) the Appliance is damaged by:
 - (i) accident
 - (ii) misuse or abuse, including failure to properly maintain or service
 - (iii) normal wear and tear
 - (iv) power surges, electrical storm damage or incorrect power supply
 - (v) incomplete or improper installation
 - (vi) incorrect, improper or inappropriate operation
 - (vii) insect or vermin infestation
 - (viii) failure to comply with any additional instructions supplied with the Appliance;
 - (b) the Appliance is modified without authority from Electrolux in writing;
 - (c) the Appliance's serial number or warranty seal has been removed or defaced;
 - (d) the Appliance was serviced or repaired by anyone other than Electrolux, an authorised repairer or ASC.
8. This warranty, the contract to which it relates and the relationship between you and Electrolux are governed by the law applicable where the Appliance was purchased. Where the Appliance was purchased in New Zealand for commercial purposes the Consumer Guarantee Act does not apply.
9. To the extent permitted by law and subject to your non-excludable statutory rights and warranties, Electrolux excludes all warranties and liabilities (other than as contained in this document) including liability for any loss or damage whether direct or indirect arising from your purchase, use or non use of the Appliance.
10. For Appliances and services provided by Electrolux in Australia, the Appliances come with a guarantee by Electrolux that cannot be excluded under the ACL. You are entitled to a replacement or refund for a major failure and for compensation for any other reasonably foreseeable loss or damage. You are also entitled to have the Appliance repaired or replaced if the Appliance fails to be of acceptable quality and the failure does not amount to a major failure. The benefits to you given by this warranty are in addition to your other rights and remedies under a law in relation to the Appliances or services to which the warranty relates.
11. At all times during the Warranty Period, Electrolux shall, at its discretion, determine whether repair, replacement or refund will apply if an Appliance has a valid warranty claim applicable to it.
12. For Appliances and services provided by Electrolux in New Zealand, the Appliances come with a guarantee by Electrolux pursuant to the provisions of the Consumer Guarantees Act, the Sale of Goods Act and the Fair Trading Act.
13. To enquire about claiming under this warranty, please follow these steps:
 - (a) carefully check the operating instructions, user manual and the terms of this warranty;
 - (b) have the model and serial number of the Appliance available;
 - (c) have the proof of purchase (e.g. an invoice) available;
 - (d) telephone the numbers shown below.
14. You accept that if you make a warranty claim, Electrolux and its ASC may exchange information in relation to you to enable Electrolux to meet its obligations under this warranty.

Important Notice

Before calling for service, please ensure that the steps listed in clause 13 above have been followed.

<p>FOR SERVICE or to find the address of your nearest state service centre in Australia PLEASE CALL 13 13 49 For the cost of a local call (Australia only)</p>	<p>SERVICE AUSTRALIA  Electrolux ELECTROLUX HOME PRODUCTS www.electrolux.com.au</p>	<p>FOR SPARE PARTS or to find the address of your nearest state spare parts centre in Australia PLEASE CALL 13 13 50 For the cost of a local call (Australia only)</p>
<p>FOR SERVICE or to find the address of your nearest authorised service centre in New Zealand FREE CALL 0800 10 66 10 (New Zealand only)</p>	<p>SERVICE NEW ZEALAND  Electrolux ELECTROLUX (NZ) Limited www.electrolux.co.nz</p>	<p>FOR SPARE PARTS or to find the address of your nearest state spare parts centre in New Zealand FREE CALL 0800 10 66 20 (New Zealand only)</p>

For more information on all Westinghouse appliances,
or for dimension and installation information, call into your retailer,
phone or email our customer care team or visit our website:

AUSTRALIA

phone: 1300 363 640
fax: 1800 350 067
email: customercare@electrolux.com.au
web: www.westinghouse.com.au

NEW ZEALAND

phone: 0800 436 245
fax: 0800 225 088
email: customercare@electrolux.co.nz
web: www.westinghouse.co.nz

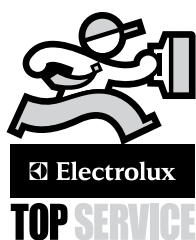

TOP SERVICE

Top Service encompasses the after sales service provided by The Electrolux Group to consumers including delivery, home service and spare parts.

Westinghouse. We are part of the Electrolux family.
Share more of our thinking at www.electrolux.com.au

© 2014 Electrolux Home Products Pty Ltd ABN 51 004 762 341
Print code: WMAN_Fridge_Oct14
Part number: 1458640

Issue date: October 14