

PULL OUT SHELF

700mm = ACC169

800mm = ACC170

GENERAL WARNINGS

Please read the user manual carefully and store in a handy place for later reference. Pass the user manual on to possible new owners of the appliance.

Read the following carefully to avoid damage or injury.

NOTE: You must read these warnings carefully before installing or using the accessory. If you need assistance, contact your Customer Care Department. The manufacturer will not accept liability, should these instructions or any other safety instructions incorporated in this book be ignored.

NOTE: There are two variants of the Westinghouse Pull Out Shelf. Both look similar except for their width. Please ensure you have purchased a Pull Out Shelf which has the same width as your fridge.



ENVIRONMENT

Remove and discard any packaging material before using this accessory. Most of the packaging materials are recyclable. Please dispose of those materials through your local recycling depot or by placing them in the appropriate collection containers.



WARNING

Risk of suffocation, injury or permanent disability.

- This accessory is not intended for use by persons (including children) with reduced physical, sensory or mental capabilities, or lack of experience and knowledge, unless they have been given supervision or instructions concerning the use of the appliance by a person responsible for their safety.
- This accessory may contain small parts that are a choking hazard. Not suitable for children under 3 years of age.



CAUTION

It is important to use your appliance safely. Check these safety points before using your appliance.

- Do not use or place the accessory near the edge of the table or counter, near hot gas, stove, electric burner or heated oven.
- This accessory is for indoor use only.
- This accessory is intended for domestic use only. Electrolux will not accept any liability for possible damage caused by improper or incorrect use.
- When cleaning, use only a soft cloth with an unscented mild soap and lukewarm water.
- Never use hot water, solvents, commercial kitchen cleaners, aerosol cleaners, metal polishes, caustic or abrasive cleaners, or scourers to clean the accessory, as they may damage it. Many commercially available cleaning products and detergents contain solvents that will damage your accessory.

DESCRIPTION

The Pull Out Shelf is designed to extend out to align with the cabinet opening.

To extend or retract the shelf, simply pull or push the front edge until the shelf locates against the stops on the frame.

Frame

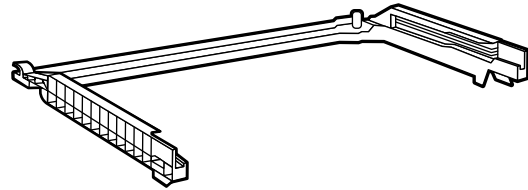

Shelf

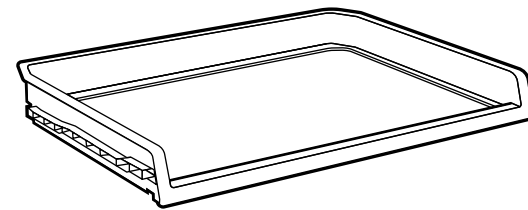

Retracted shelf

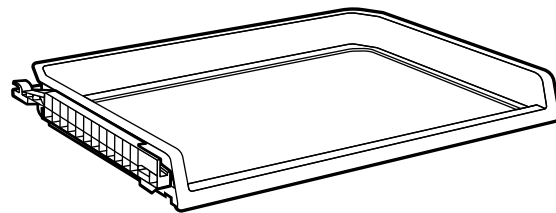

Extended shelf

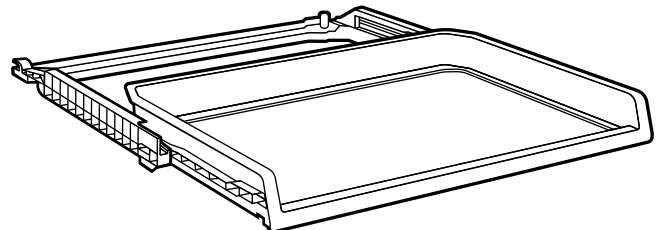

OPERATION

Installing the Pull Out Shelf for the first time: Frame and Tray together



CAUTION

Pull Out Shelf cannot be placed in the same location as the Door Switch.

1. Place the shelf on the lugs.

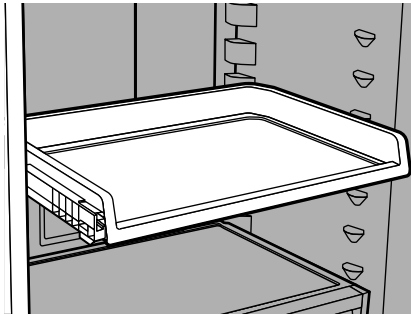

2. Push the shelf straight inwards until its clip gets locked in the rear pocket.

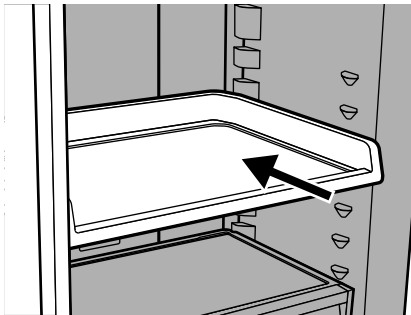

3. Remove the tape.

Removing the shelf

1. Extend the tray fully outward.

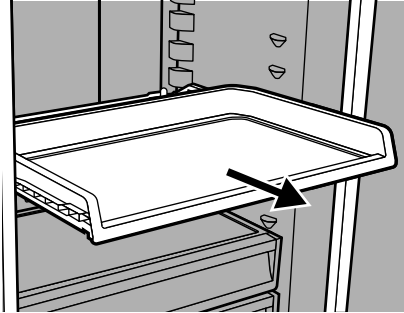

2. Push the tray up gently and then forward to remove the tray from the frame.

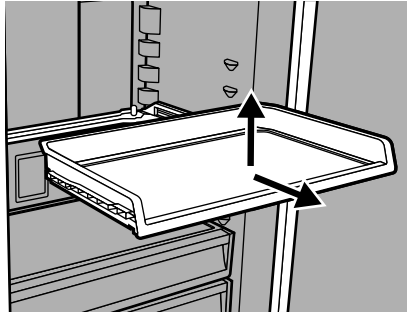

3. Pushing the tab gently inwards on both sides of the frame, pull the frame towards you to remove it from the cabinet.

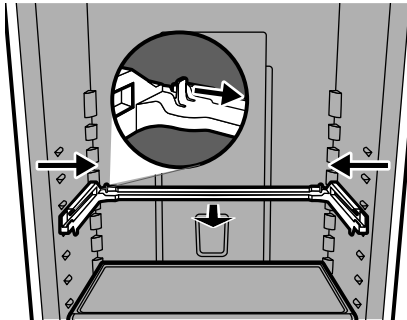

Reinstalling the Pull Out Shelf after removing from the fridge

1. Place the frame on the lugs.

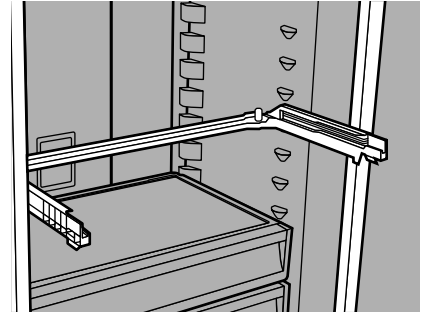

2. Push the frame straight inwards until its clip gets locked in the rear pocket.

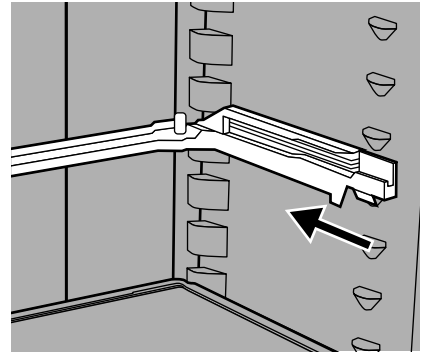

3. Place the tray on to the frame slot.

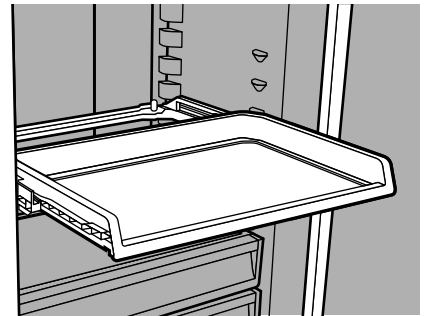

4. Slide the tray inwards until it is stopped in position.

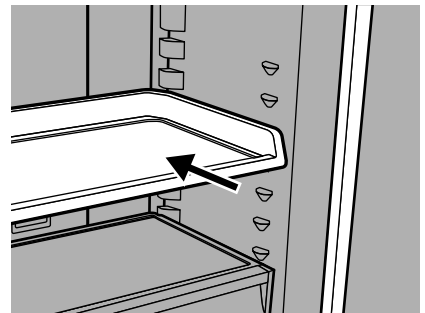

For more information on all Westinghouse appliances, or for dimension and installation information, call into your retailer, phone or email our customer care team or visit our website:

AUSTRALIA

phone: 1300 363 640
 fax: 1800 350 067
 email: customercare@electrolux.com.au
 web: westinghouse.com.au

NEW ZEALAND

phone: 0800 436 245
 fax: 0800 225 088
 email: customercare@electrolux.co.nz
 web: westinghouse.co.nz

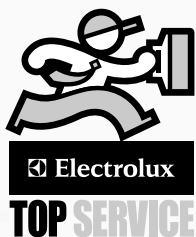

TOP SERVICE

Top Service encompasses the after sales service provided by The Electrolux Group to consumers including delivery, home service and spare parts.

Westinghouse. We are part of the Electrolux family.
 Share more of our thinking at electrolux.com.au

Important Notice

<p>FOR SERVICE or to find the address of your nearest state service centre in Australia PLEASE CALL 13 13 49 For the cost of a local call (Australia only)</p>	<p>SERVICE AUSTRALIA  ELECTROLUX HOME PRODUCTS electrolux.com.au</p>	<p>FOR SPARE PARTS or to find the address of your nearest state spare parts centre in Australia PLEASE CALL 13 13 50 For the cost of a local call (Australia only)</p>
<p>FOR SERVICE or to find the address of your nearest authorised service centre in New Zealand FREE CALL 0800 10 66 10 (New Zealand only)</p>	<p>SERVICE NEW ZEALAND  ELECTROLUX (NZ) Limited electrolux.co.nz</p>	<p>FOR SPARE PARTS or to find the address of your nearest state spare parts centre in New Zealand FREE CALL 0800 10 66 20 (New Zealand only)</p>

 and WESTINGHOUSE are trademarks of Westinghouse Electric Corporation. Used under license. All Rights Reserved.