

## **900mm COOKING APPLIANCES**

WFE914SB, WFEP915SB, WFE946SB

WVE914SB, WVE916SB, WVEP916SB

## CONGRATULATIONS

Congratulations and thank you for choosing our product.

We are sure you will find your new cooker a pleasure to use and a great asset to your cooking. Before you use the appliance, we recommend you read through the whole user manual which provides a description of the product and its functions.

To avoid the risks that are always present when you use an appliance, it is important that the appliance is installed correctly and that you read the safety instructions carefully to avoid misuse and hazards. We recommend that you keep this instruction booklet for future reference and pass it on to any future owners.

This appliance complies with the requirements of Australian Standard AS/NZS 60335.2.6. Gas appliances also comply with the requirements of AS4551.

### Conditions of use

This appliance is intended to be used in household and similar applications such as:

- Staff kitchen areas in shops, offices and other working environments
- Farm houses
- By clients in hotels, motels and other residential type environments
- Bed and breakfast type environments

**Please ensure you read the instruction manual fully before you call for service, or a full service fee could be applicable.**

Record model and serial number here:

Model number:.....

Serial number:.....

PNC:.....

## CONTENTS

Important safety instructions.....	3
Description of your appliance:	
WFE914SB.....	5
WFEP915SB.....	6
WFE946SB.....	7
WVEP916SB.....	8
WVE916SB.....	8
WVE914SB.....	8
Before operating your appliance for the first time.....	9
Installing your oven accessories.....	10
Installing your cooktop accessories.....	10
Getting to know your cooktop.....	12
Using your ceramic cooktop.....	15
Using your oven.....	18
Cooking test.....	24
Cooking guide.....	25
Dealing with cooking problems.....	28
Cleaning your appliance.....	29
Cleaning oven accessories.....	30
Cleaning your pyrolytic oven.....	31
Storage.....	32
Troubleshooting.....	33
Installation of the appliance.....	37
Wiring requirements.....	42
Installing the gas cooker.....	43
LPG Conversion.....	44
Testing the operation of the gas cooker.....	45
Warranty.....	47

Please read the user manual carefully and store in a handy place for later reference.

The symbols you will see in this booklet have these meanings:



### WARNING

This symbol indicates information concerning your personal safety.



### CAUTION

This symbol indicates information on how to avoid damaging the appliance.



### IMPORTANT

This symbol indicates tips and information about use of the appliance.



### ENVIRONMENT

This symbol indicates tips and information about economical and ecological use of the appliance.

# IMPORTANT SAFETY INSTRUCTIONS

## IMPORTANT INFORMATION THAT MAY IMPACT YOUR MANUFACTURER'S WARRANTY

Adherence to the directions for use in this manual is extremely important for health and safety. Failure to strictly adhere to the requirements in this manual may result in personal injury, property damage and affect your ability to make a claim under the Westinghouse manufacturer's warranty provided with your product. Products must be used, installed and operated in accordance with this manual. You may not be able to claim on the Westinghouse manufacturer's warranty in the event that your product fault is due to failure to adhere to this manual.

Please read the user manual carefully and store in a handy place for later reference. Pass the user manual on to possible new owners of the appliance.

Read the following carefully to avoid damage or injury.

**NOTE: You must read these warnings carefully before installing or using the appliance. If you need assistance, contact your Customer Care Department. The manufacturer will not accept liability, should these instructions or any other safety instructions incorporated in this book be ignored.**



## WARNING

### General warnings

- This appliance must not be used as a space heater.
- In order to avoid fire, the appliance must be kept clean and vents kept unobstructed.
- Do not spray aerosols in the vicinity of this appliance whilst it is in operation.
- Do not use or store flammable materials in this appliance storage drawer or near this appliance.
- Do not line the bottom of the oven with foil or cookware.
- Always use gloves when handling hot items inside the oven.
- Always turn the grill off immediately after use as fat left behind may catch fire.
- Do not hang any objects from the hob as it may block the air vents.
- Do not modify this appliance.
- To maintain safe operation, it is recommended that the product be inspected every 5 years by an authorised service person.
- Do not install an aftermarket lid or cover over this appliance.
- The cooking process must be supervised. A short term cooking process must be supervised continuously.

### Installation, cleaning and servicing

- An authorised person must install this appliance. (Certificate of Compliance to be retained).
- Before using the appliance, ensure that all packing materials are removed from the appliance.
- In order to avoid any potential hazard, the enclosed installation instructions must be followed.
- Ensure that all specified vents, openings and airspaces are not blocked.
- Where the appliance is built into a cabinet, the cabinet material must be capable of withstanding 85°C.
- Only authorised personnel should carry out servicing. (Certificate of Compliance to be retained).
- Always ensure the appliance is switched off before cleaning or replacing parts.
- Do not use steam cleaners, as this may cause moisture build up.
- Always clean the appliance immediately after any food spillage.
- This appliance must be earthed.
- Due to the weight (freestanding 95-100kg, built in 70kg) and size of cookers, 2 persons are required to manually manoeuvre them. Remove loose items such as trivets, oven racks and trays to minimise weight.
- Do not use the handle to lift the cooker, instead open the oven door and lift the roof of the oven cavity.
- Take care when lifting to avoid any sharp edges not intended for lifting.
- This cooker must not be installed with a cut-off timer.

# IMPORTANT SAFETY INSTRUCTIONS



## Oven

- During use the appliance becomes hot. Care should be taken to avoid touching the hot surfaces inside the oven.
- Switch the appliance off at the isolating switch before removing the oven light glass for globe replacement.
- To avoid an accident, ensure that oven shelves and fittings are always inserted into the appliance in accordance with the instructions.
- Do not use the door as a shelf.
- Do not push down on the open oven door.
- Do not cover the grill insert with foil, as fat left there may catch fire.
- Always keep the grill dish clean as any fat there may catch fire.

## Gas cooktops

- Do not allow pots to boil dry, as damage to both pan and cooktop may result.
- Do not operate the cooktop for an extended period of time without a pot or pan on the burner.
- Do not allow large cookware to overhang the cooktop onto the adjacent benchtop. This will cause scorching to the benchtop surface.
- Do not allow cooking pots or pans to intrude into the area which is close to the controls.
- Ensure burner bodies and trivets are properly located.
- Unattended cooking with oil or fat on a hob can be dangerous and result in fire.
- In order to avoid a fire do not store items on the cooking surface.

## Ceramic cooktops

- In order to avoid a fire do not store items on the cooking surface.
- Do not place heat resistant mats, wire mats or aluminium foil under pots and pans.
- Do not allow pots to boil dry, as damage to both pan and cooktop may result.
- Do not use the hotplate as extra bench space or as a cutting board.
- Do not allow large cookware to overhang the cooktop onto the adjacent benchtop. This will cause scorching to the benchtop surface.
- Do not use round bottom woks or similar utensils which could lead to overheating of the hotplates and possible damage to the cooking surface.
- Use the stored heat in the hotplate by turning the control to off before the final few minutes of cooking.
- Do not slide pans across the surface of the ceramic glass as it could result in scratching of the surface.
- The ceramic cooktop is not intended to be operated by means of an external timer or separate remote-control system.
- Unattended cooking with oil or fat on a hob can be dangerous and result in fire.



## Child safety

- This appliance is not intended for use by persons (including children) with reduced physical, sensory or mental capabilities, or lack of experience and knowledge, unless they have been given supervision or instruction concerning use of the appliance by a person responsible for their safety.
- Children should be supervised to ensure that they do not play with the appliance.
- During use this appliance becomes hot. Care should be taken to avoid touching hot surfaces, e.g. oven door, heating elements etc.
- Accessible parts will also become hot when in use. To avoid burns and scalds children should be kept away.
- Always turn pan handles to the side or rear to prevent accidental knocking and to keep out of reach of children.

# MODEL WFE914SB

Gas hob with flame safeguard, multi-function electric oven with touch control timer

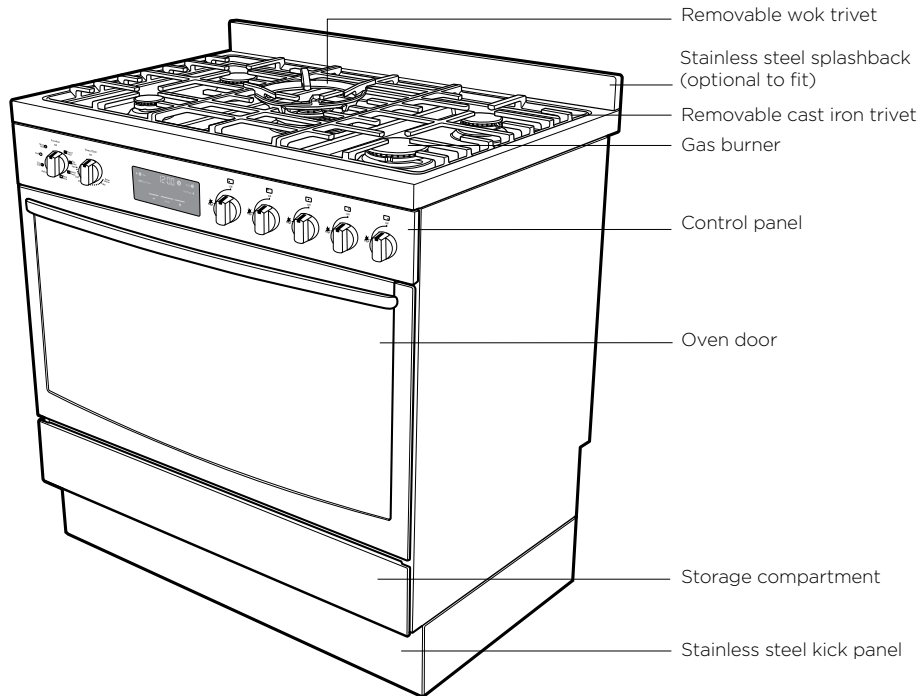

## Control Panel

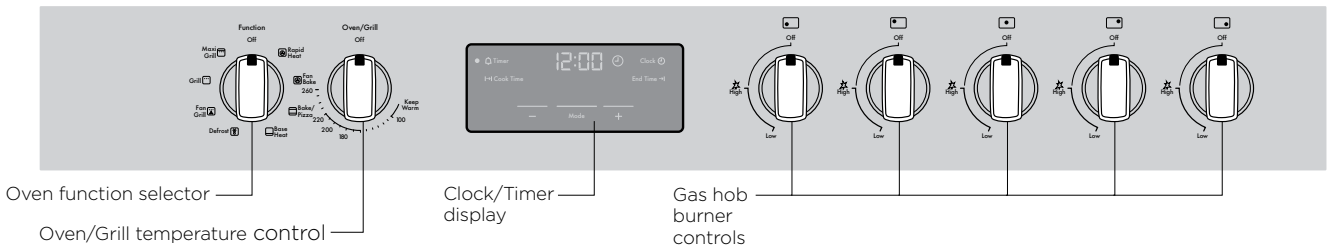

Oven function selector

Oven/Grill temperature control

Clock/Timer display

Gas hob burner controls

## Gas Hob

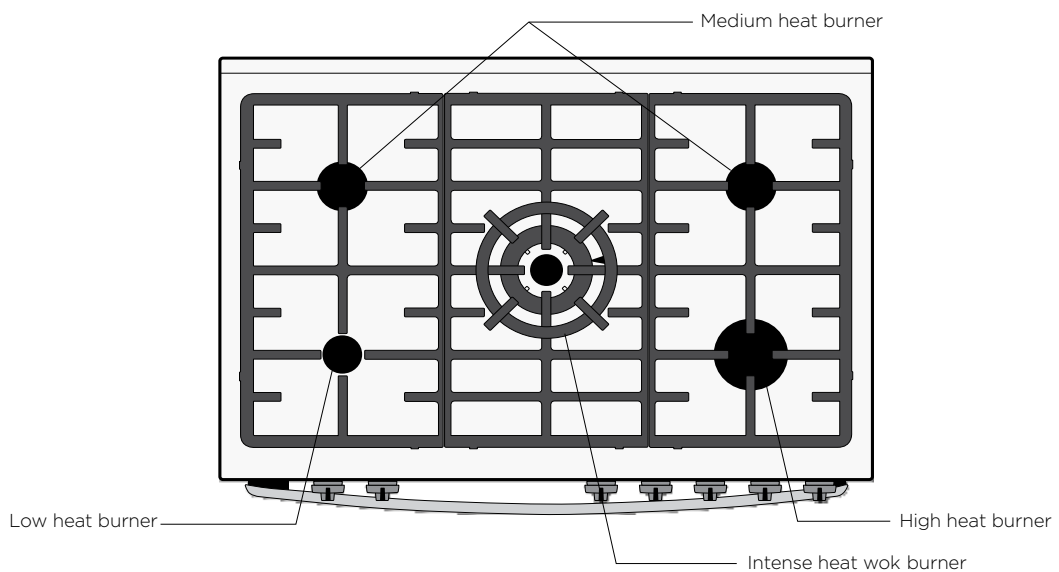

Low heat burner

Medium heat burner

Intense heat wok burner

High heat burner

# MODEL WFEP915SB

Gas hob with flame safeguard, programmable touch control pyro clean electric oven

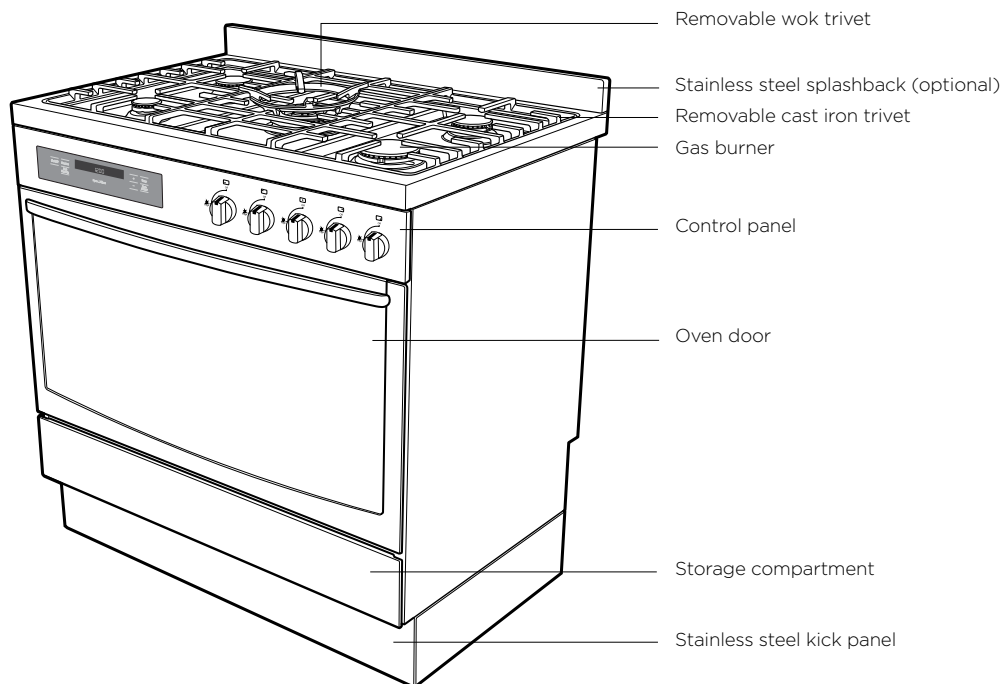

## Control Panel

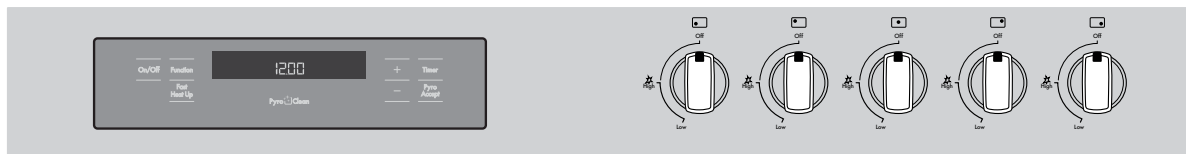

Programmable controller

Gas hob burner controls

## Gas Hob

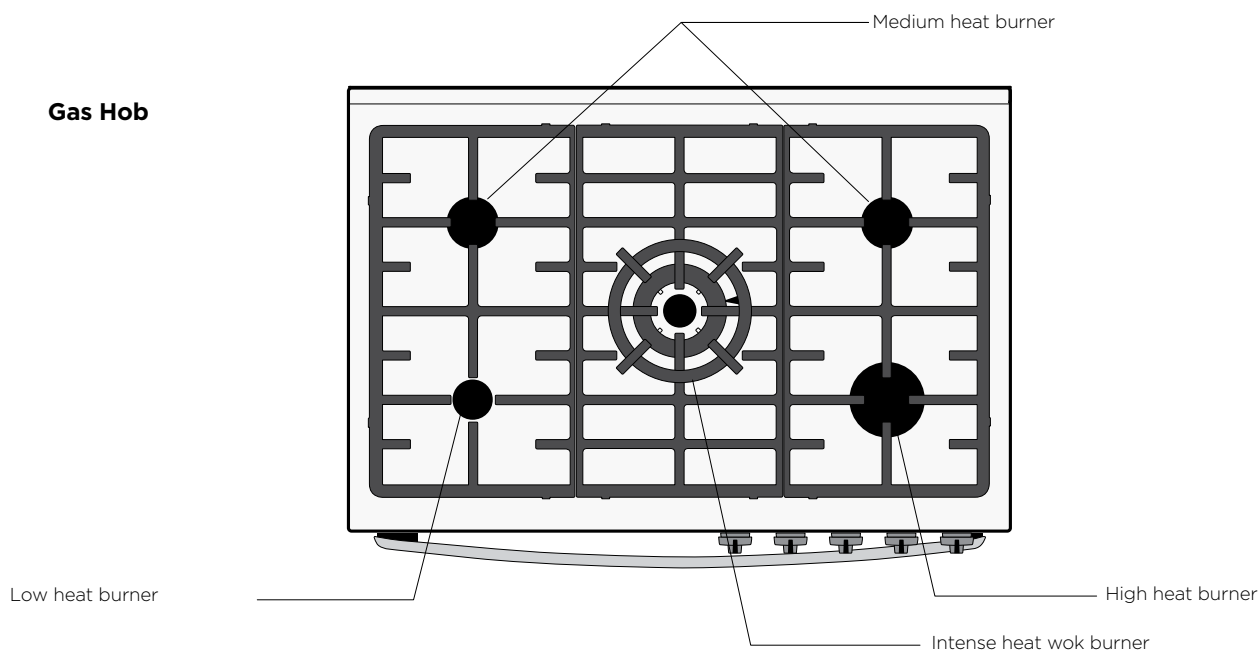

# MODEL WFE946SB

Touch control electric ceramic hob, programmable touch control electric oven

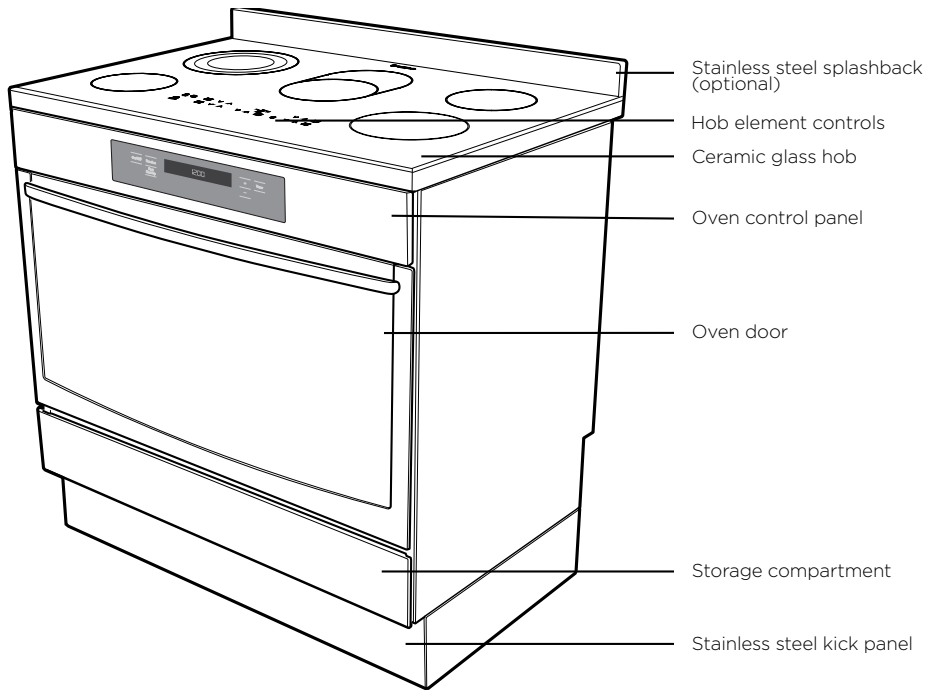

## Ceramic hob touch controls

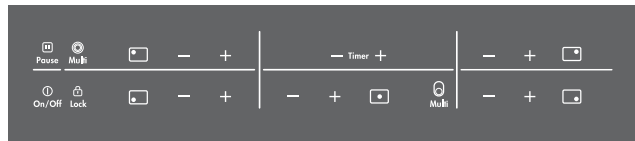

## Control Panel - oven programmable controller



## Ceramic Hob

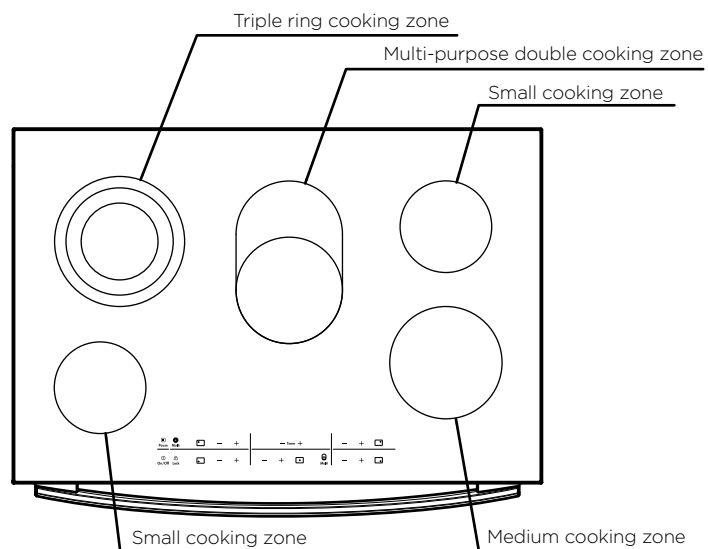

## MODEL WVEP916SB

Pyro Clean programmable electric oven

## MODEL WVE916SB

Programmable electric oven

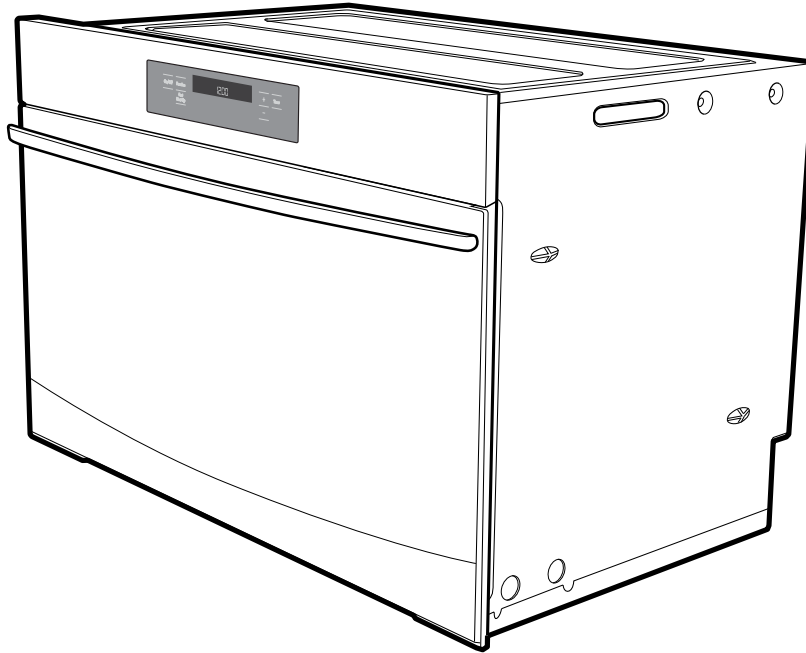

Control Panel - oven programmable controller  
WVEP916SB

WVE916SB

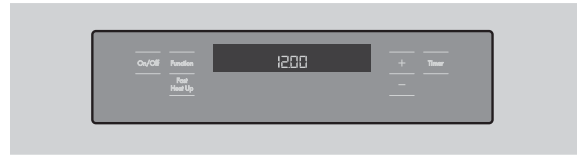
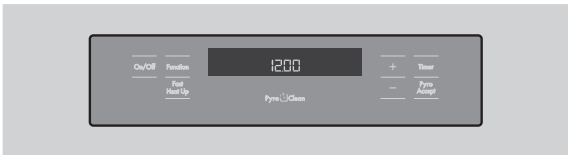

## WVE914SB

Knob control electric oven

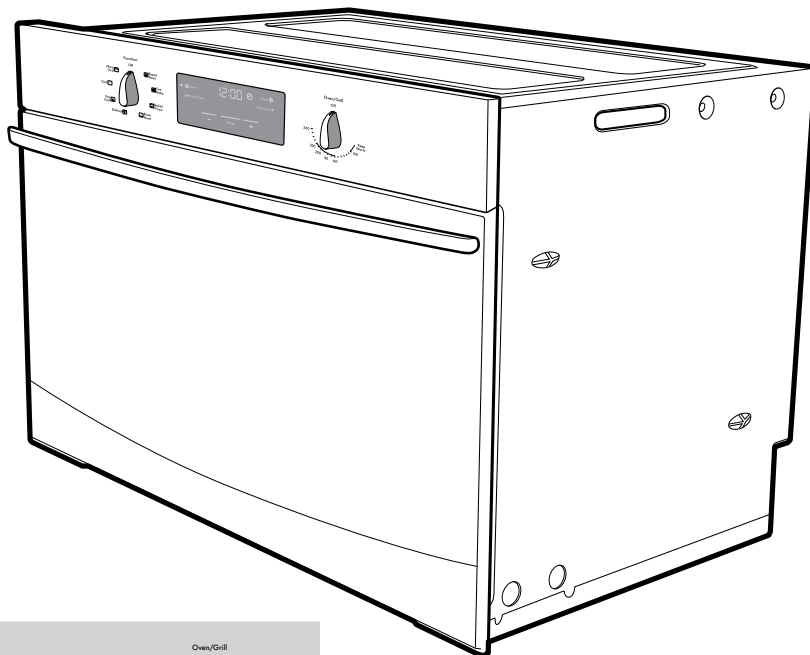



# BEFORE OPERATING YOUR APPLIANCE FOR THE FIRST TIME



## TIPS AND INFORMATION

### Setting the time

If you have purchased a model fitted with an electronic or programmable timer, you must set the time of day before you can operate your appliance.

After electrically connecting the appliance, you must set the time of the day before you can operate your oven.

### Touch control electronic clock model wfe914SB, WVE914SB

- After the appliance has been electrically connected "12.00" will be displayed and the "clock" indicator will flash.
- To set the time of day, press - or +. 5 seconds after the last change, the "clock" indicator will disappear, confirming the time has been set.

*NOTE: The clock has a 24-hour display.*



Model wfe914

### Programmable Controller: models WFEP915SB, WFE946SB, WVEP916SB, WVE916SB

- After the appliance has been electrically connected, the set clock symbol ⌚ will flash on the clock display.
- To set the time of day, press - or +. 5 seconds after the last change the timer arrow ▶ will disappear, confirming the time has been set. Once the time has been entered, the clock advances minute by minute.

*NOTE: The clock has a 24-hour display.*



Model wfe916

### Preparing your appliance for the first time

- Please remove all internal boxes and bags from the oven before operation.
- Please wipe out the oven interior prior to operation with warm soapy water and polish dry with a soft clean cloth. Do not close the oven door until the oven is completely dry.
- New appliances can have an odour during first operation. It is recommended to 'run in' your oven before you cook for the first time. Run the oven at 180°C for 2 hours and ensure that the room is well ventilated.
- DO NOT line the oven with foil, it will damage the enamel.

## INSTALLING YOUR OVEN ACCESSORIES

Prior to installing accessories, remove all packaging and remove plastic film from external panels.

### Side racks

The side racks that come with your oven are fitted in the following manner:

- Insert the rear peg into the rear access hole provided, ensuring peg is fully inserted.
- Then locate the front peg into the front access hole and push in firmly.

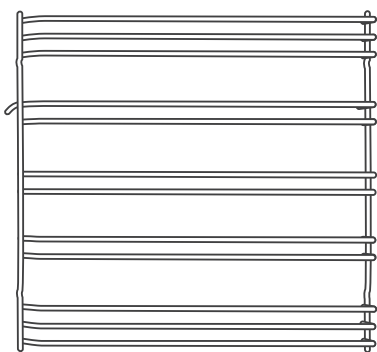
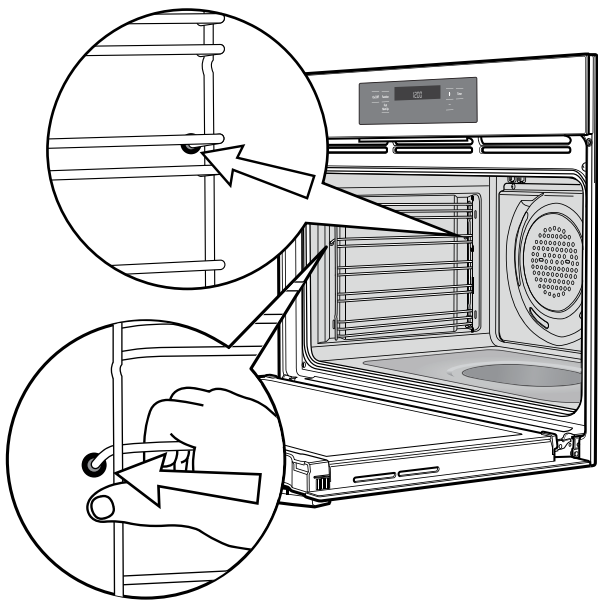

### Shelves and trays

The shelves are designed so that they have maximum travel but cannot be accidentally pulled right out. The trays are designed in the same way and fit straight into the side racks.

- Locate the rear edge of the shelf/tray in between 2 guide rails of the side rack – see diagram. Ensure the same rail positions on both sides of the oven are being engaged.
- With the front edge raised, begin to slide the shelf into the oven.

- Once the indents have passed the front edge of the side rack, the shelf can be pushed completely in.
- When fully inserted the shelf/tray should not interfere with the closed door.

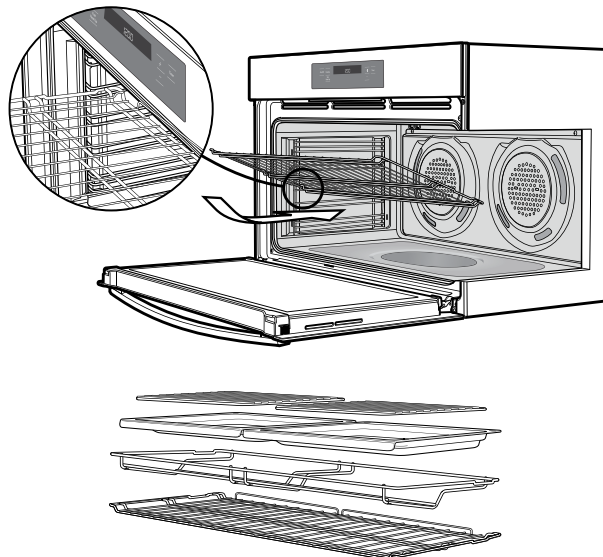

### Installing burners

- The burner crown must be fitted correctly into the burner cup or damage will occur during operation.
- To do this, ensure that the 2 ribs on either side of the spark plug hole are positioned into the 2 slots on the burner cup.
- The burner cap and burner crown must be clean and located correctly for the burner to light.

*NOTE: When the burner is correctly fitted it will sit level on the hob.*

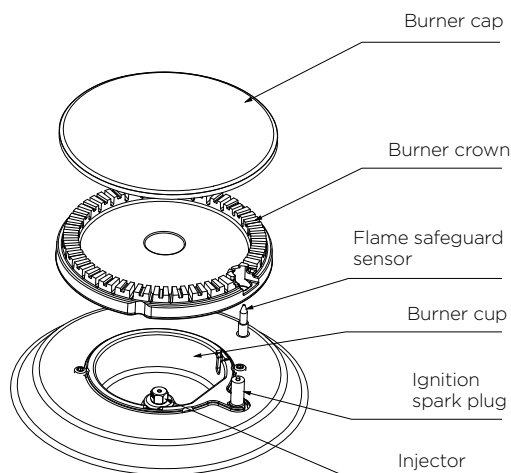

## INSTALLING YOUR COOKTOP ACCESSORIES

### Installing trivets

- The rubber feet on the trivets locate into the contours of the hob
- Take care when placing the trivets as dropping them may damage the hob or trivet
- The wok trivet sits on top of the trivet above the wok burner

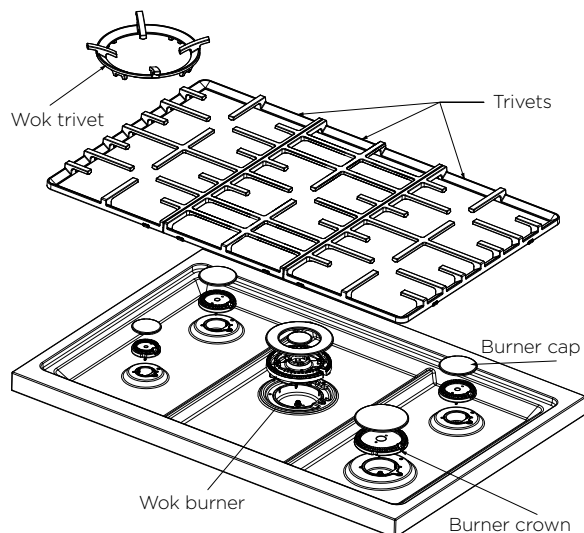

### Using your gas hotplates

*Note: Gas controls turn anti-clockwise from 'Off' and have limited movement.*

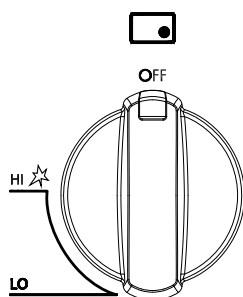

## INSTALLING BURNERS AND TRIVETS

### Lighting the burners

#### Electronic ignition

These hobs are fitted with mains powered electronic ignition. When the appliance has been connected and the power is on, depressing any knob will release sparks to all burners. To light a burner, depress the corresponding knob and while continuing to depress knob turn anti-clockwise to 'HI' position. The knob may be released once the flame is established, and turned further anti-clockwise to reduce the flame height as desired.

#### Flame safeguard models WFE914SB & WFEP915SB

Models with flame safeguard have the same ignition procedure as electronic ignition, but require the knob to continue to be depressed after flame is established for approximately 5 seconds. If the flame goes out when the knob is released, simply depress the knob again, this time holding it down with slightly more force for the same length of time.



#### WARNING

- Keep hands clear of burners when lighting.
- If burner does not light within 5 seconds, turn knob to 'Off' position, allow gas to disperse, then try lighting again.
- Burners MUST be operated between 'HIGH' and 'LOW' settings only.



#### ENVIRONMENT

To conserve gas, place the pan centrally over the burner and adjust the flame so that it does not go past the edge of the cookware.

*NOTE: In the absence of electrical power, carry out the ignition directly to the burner with a hand held ignition source.*

# GETTING TO KNOW YOUR COOKTOP

## Model WFEP915SB & WFE914SB

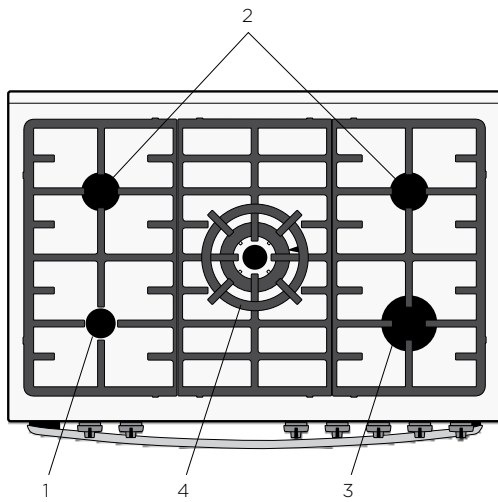

### 1. Low heat burner (5.1MJ/h)

Used for simmering with small cookware items.

### 2. Medium heat burner (9.0MJ/h)

Used for normal cooking and simmering with mid size cookware items.

### 3. High heat burner (12.1MJ/h)

Used for fast heating with large size cookware items.

### 4. Intense heat wok burner (14.4MJ/h)

Used for very fast heating with woks and other large size cookware items. Use wok trivet provided when cooking with a wok.

## Ceramic hotplates Model wfe946SB

The cooktop is made from ceramic glass, a tough, durable material that withstands heating and cooling without breaking. It is strong enough to hold the heaviest utensils.

However, it must be remembered that as it is GLASS, it may break. Treat it accordingly!

Should you have any questions about the glass in your new appliance, please contact the service centre by dialling 13 13 49.

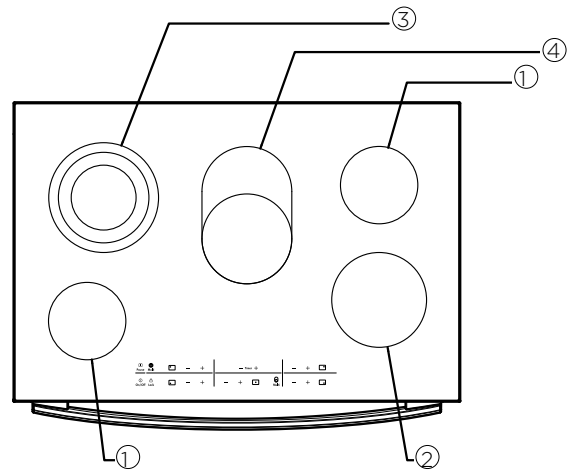

1. Single cooking zone small 1200W

2. Single cooking zone medium 1800W

3. Triple cooking zone 2300/1600/800W

4. Multi-purpose double cooking zone 2200/1400W

## **WARNING**

If the ceramic glass is cracked, switch off the appliance to avoid the possibility of electric shock.

The heating elements are concealed under the smooth glass surface which has a pattern to show the location of the elements.

- Use pans with smooth, clean and dry bottoms to avoid scratching or burning residue into the glass.
- Ensure the pan bottom is the same size as the working element.
- We do not recommend ceramic glass pans because they do not conduct heat well.
- Stainless steel or enamelled saucepans are best.
- Do not use pans with copper or aluminium bottoms because they can leave traces which are difficult to remove from the glass.
- If buying new utensils select enamelled steel pans with 2-3mm thick bottoms or stainless steel pans with sandwich bottoms 4-6mm thick. The pan bottom should be flat, or preferably, slightly concave at room temperature so that it lies flat on the glass surface when hot.

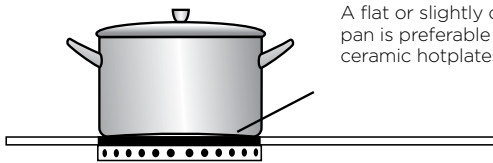

A flat or slightly concave pan is preferable for ceramic hotplates

## **ENVIRONMENT**

The bottom of pans and cooking zones should be the same size

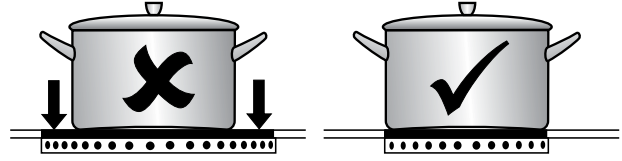

# GETTING TO KNOW YOUR CERAMIC COOKTOP

## Ceramic cooktop controls

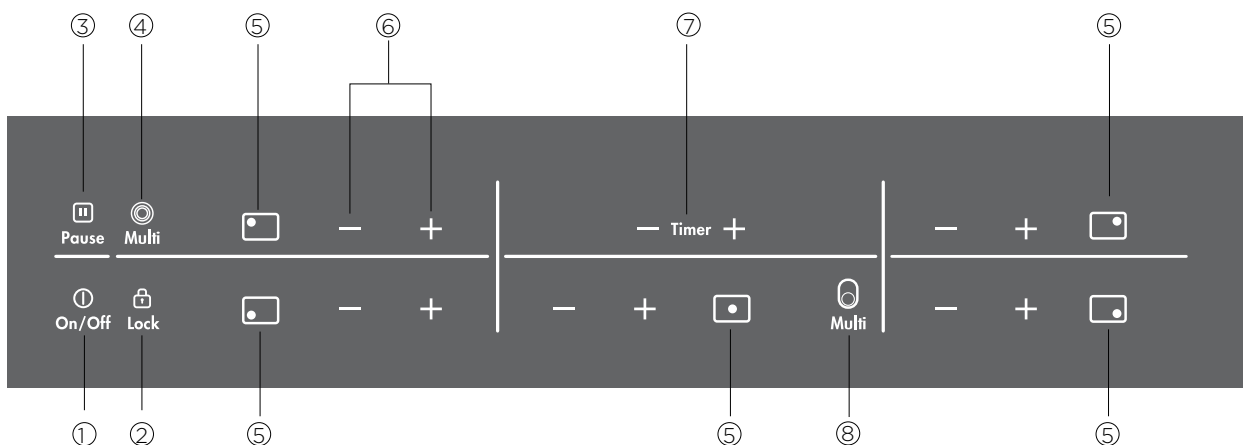

1. On/Off with power indicator
2. Lock with pilot light
3. Pause
4. Triple ring cooking zone
5. Zone indicator
6. Heat setting selection
7. Timer setting selection
8. Multipurpose cooking zone

The appliance is operated using Touch Control sensor fields. Functions are controlled by touching sensor fields and confirmed by displays and acoustic signals. Touch the sensor fields from below, without covering other sensor fields.

ICONS	SENSOR FIELD	FUNCTION
ⓘ	On / Off	To switch the appliance on and off
+	Increase settings	To increase heat settings
-	Reduce settings	To reduce heat settings
Timer	Timer	To select timer settings
+	Increase settings	To increase Timer time
-	Reduce settings	To reduce Timer time
🔒	Lock	To lock/unlock the control panel
🌀	Triple ring switch	To switch outer rings on and off
🌀	Multi-purpose zone switch	Link zones on and off
⏸	Pause	Sets all operating zones to Keep Warm setting

## Displays

DISPLAY	DESCRIPTION
0	Cooking zone is switched off
W	Keep warm setting is set
1-9	Heat setting is set
A	Automatic warm-up function is activated
E	Malfunction has occurred
H	Cooking zone is still hot
L	Lock/child safety device is activated
-	Switch off is active



### WARNING

Risk of burns from residual heat. After being switched off, the cooking zones need some time to cool down. Look at the residual heat indicator **H**.



### TIPS AND INFORMATION

Residual heat can be used for melting and keeping food warm.

These touch controls apply to the hob only. The oven is operated independently.

# USING YOUR CERAMIC COOKTOP

## Switching the ceramic cooktop on and off

	CONTROL PANEL	DISPLAY
Switch on	Touch <b>⏻</b> for 2 seconds	<b>⏻</b> / <b>H</b>
Switch off	Touch <b>⏻</b> for 2 seconds	<b>H</b> / none

### **i** TIPS AND INFORMATION

After switching on, within approx. 10 seconds a heat setting or a function must be set, otherwise the appliance automatically switches itself off.

## Setting the heat setting

	CONTROL PANEL	DISPLAY
To increase	Touch <b>+</b>	<b>⏻</b> to <b>Ⓜ</b>
To decrease	Touch <b>-</b>	<b>Ⓜ</b> to <b>⏻</b>
To switch off	Touch <b>-</b> until <b>⏻</b>	<b>⏻</b>

### **i** TIPS AND INFORMATION

The keep warm setting **Ⓜ** lies between **⏻** and **Ⓜ**. It is used to keep food warm.

## Switching the outside ring on and off

By switching the outside rings on or off, the effective heating surface can be matched to the size of the cookware.

### **i** TIPS AND INFORMATION

Before an outside ring can be switched on, the inside ring must be switched on.

TRIPLE COOKING ZONE	CONTROL PANEL	INDICATOR LIGHT
To switch on the middle ring	Touch <b>Ⓜ</b> for 1-2 seconds	Two indicator lights are lit
To switch on the outside ring	Touch <b>Ⓜ</b> for 1-2 seconds	Three indicator lights are lit
To switch off the outside ring	Touch <b>Ⓜ</b> for 1-2 seconds	The third indicator light goes out
To switch off the middle ring	Touch <b>Ⓜ</b> for 1-2 seconds	The second indicator light goes out

MULTI-PURPOSE ZONE	SENSOR FIELD	INDICATOR LIGHT
To switch on the outside ring	Touch <b>Ⓜ</b> for 1-2 seconds	is lit
To switch off the outside ring	Touch <b>Ⓜ</b> for 1-2 seconds	goes out

## Locking/unlocking the control panel

The control panel, with the exception of the 'On/Off' sensor field, can be locked at any time in order to prevent the settings being changed eg. By wiping over the panel with a cloth.

	CONTROL PANEL	DISPLAY
Switch on	Touch <b>Ⓜ</b>	<b>Ⓜ</b> (for 5 seconds)
Switch off	Touch <b>Ⓜ</b>	the previously set heat settings

### **i** TIPS AND INFORMATION

When you switch the appliance off, the locking function is automatically switched off.

## Using the automatic warm-up function

All cooking zones are equipped with an automatic warm up function. When setting a heat setting using **+**, when starting from **⏻**, the cooking zone switches to full power for a certain amount of time and then automatically switches back to the heat setting set.

	CONTROL PANEL	POSSIBLE HEAT SETTINGS	DISPLAY
Switch on (only when starting at <b>⏻</b> )	Touch <b>+</b>	<b>Ⓜ</b> to <b>Ⓜ</b>	<b>Ⓜ</b> (after 5 seconds)
Switch off	Touch <b>-</b>	<b>Ⓜ</b> to <b>Ⓜ</b> / <b>Ⓜ</b>	<b>Ⓜ</b> to <b>Ⓜ</b>
Not used	Touch <b>-</b>	<b>Ⓜ</b> to <b>Ⓜ</b>	<b>Ⓜ</b> to <b>Ⓜ</b>

### **i** TIPS AND INFORMATION

If during the automatic warm up **Ⓜ** a higher heat setting is selected, e.g. from **Ⓜ** to **Ⓜ**, the automatic warm up is adjusted.

If there is still residual heat on the cooking zone (display **Ⓜ**), the automatic warm up is not performed.

## USING YOUR CERAMIC COOKTOP



The length of time that the automatic warm up function operates depends on the heat setting selected.

HEAT SETTING	AUTOMATIC WARM UP (MIN:SEC)
0	0.30
1	1.00
2	1.40
3	4.50
4	6.30
5	10.10
6	2.00
7	3.30
8	4.30
9	- - -

### Using the child safety device



The child safety device prevents unintentional use of the appliance.

#### Switching on the child safety device

STEP	CONTROL PANEL	DISPLAY
1.	ⓘ Switch the appliance on (Do not set a heat setting)	0
2.	Touch  for 4 seconds	

The child safety device is switched on

#### Switching off the child safety device



STEP	CONTROL PANEL	DISPLAY
1.	ⓘ Switch the appliance on (Do not set a heat setting)	
2.	Touch  for 4 seconds	 lights up
3.	ⓘ Switch the appliance off	

The child safety device is switched off

The child safety device can only be switched on or off, if no heat setting is set.

### Overriding the child safety device

The child safety device can be switched off in this way for a single cooking session; it remains activated afterwards.

STEP	CONTROL PANEL	DISPLAY
1.	ⓘ Switch the appliance on	0
2.	Touch  for 4 seconds	 lights up

Until the appliance is next switched off, it can be used as normal. After switching off the appliance, the child safety device is active again.

### TIPS AND INFORMATION

After overriding the child safety device, a heat setting or a function must be set within approx. 10 seconds, otherwise the appliance automatically switches itself off.



## Using the timer

FUNCTION	CONDITION	OUTCOME AFTER THE TIME HAS LAPSED
Automatic cut-out	a heat setting is set	acoustic signal 00 flashes Cooking zone switches off
Countdown timer	cooking zones not in use	acoustic signal 00 flashes







### TIPS AND INFORMATION

If a heat setting is set on the cooking zone in addition to a countdown timer, the cooking zone is switched off after the time set has elapsed.

If a cooking zone is switched off, the timer function set is also switched off.

## Selecting a cooking zone

STEP	CONTROL PANEL	DISPLAY
1.	Touch Timer once	Pilot light of first cooking zone flashes 
2.	Touch Timer once	Pilot light of second cooking zone flashes 
3.	Touch Timer once	Pilot light of third cooking zone flashes 
4.	Touch Timer once	Pilot light of fourth cooking zone flashes 
5.	Touch Timer once	Pilot light of fifth cooking zone flashes 



### TIPS AND INFORMATION



If the pilot light is flashing more slowly, the heat setting can be set or modified. If other timer functions are set, after a few seconds the shortest remaining time of all the timer functions is displayed and the corresponding pilot light flashes.

## Pause

The  function sets all cooking zones that operate to the lowest heat setting .

When  operates, you cannot change the heat setting.

The  function does not stop the timer function.

- To activate this function touch  The  symbol comes on.
- To deactivate this function touch . The heat setting that you set before comes on.

## Setting the time

STEP	CONTROL PANEL	DISPLAY
1.	Select Timer cooking zone	Pilot light for the cooking zone selected flashes
2.	Touch + or -	00 to 99 minutes

After a few seconds the pilot light flashes more slowly  
The time is set  
The time counts down

## Switching off the timer function

STEP	CONTROL PANEL	DISPLAY
1.	Select Timer cooking zone	Pilot light of cooking zone selected flashes faster. Time remaining is displayed
2.	Touch -	The remaining time counts backwards to 00

The pilot light goes out

The timer function for the selected cooking zone is switched off

## Changing the time

STEP	CONTROL PANEL	DISPLAY
1.	Select Timer cooking zone	Pilot light of cooking zone selected flashes faster. Time remaining is displayed
2.	Touch - or +	01 to 99 minutes

After a few seconds the pilot light flashes more slowly  
The time is set  
The time counts down

## Displaying the time remaining for a cooking zone

CONTROL PANEL FIELD	DISPLAY
1. Select Timer cooking zone	Pilot light of cooking zone selected flashes faster. Time remaining is displayed

After a few seconds the pilot light flashes more slowly

## Switching off the acoustic signal

CONTROL PANEL FIELD	ACOUSTIC SIGNAL
1. Touch Timer	The acoustic signal to acknowledge

The acoustic signal stops

## USING YOUR CERAMIC COOKTOP

### Automatic switch off



#### Cooking surface









- If after switching on the cooking surface, a heat setting is not set for a cooking zone within approx. 10 seconds, the cooking surface automatically switches itself off.
- If one or more sensor fields are covered by objects (a pan, cloths, etc.) for longer than approx. 10 seconds, a signal sounds and the cooking surface switches off automatically.
- If all cooking zones are switched off, the cooking surface automatically switches itself off after approx. 10 seconds.

#### Control panel

- When the appliance is switched off, if one or more of the sensor fields on the control panel are covered for more than 10 seconds, an acoustic signal sounds. The acoustic signal switches itself off automatically when the sensor fields are no longer covered.

#### Cooking zones

If one of the cooking zones is not switched off after a certain time, or if the heat setting is not modified, the relevant cooking zone switches off automatically and  is displayed. Before being used again, the cooking zone must be set to .

HEAT SETTING	SWITCHES OFF AFTER
  - 	6 hours
 - 	5 hours
	4 hours
 - 	1.5 hours

### Understanding your oven functions

## USING YOUR OVEN

The following lists the oven functions available with the programmable controller (models WFEP915SB, WFE946SB, WVE916SB and WVEP916SB). Multifunction models (WFE914SB and WVE914SB) have all oven functions except for Fan Assist, Pizza and Fast Heat Up.

#### Rapid Heat

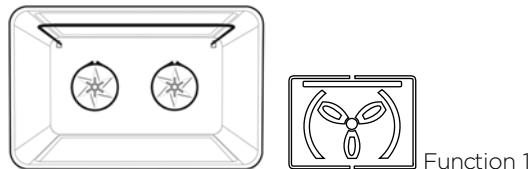

Heat comes from the elements surrounding the fans as well as the smaller element above the food. This allows you to preheat your oven 30% quicker than on standard "Bake". "Rapid Heat" is ideal for cooking frozen pre-cooked foods such as savoury dishes, pastries, pizzas, mini meals (TV dinners), meat pies and fruit pies. Simply place the food in the oven straight from the freezer and heat - ideal for busy people. Cook in the upper half of the oven for best results.

#### Fan Bake

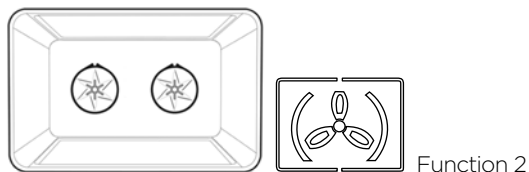

Heat comes from the elements surrounding the fans. The fans circulate the hot air around the oven cavity so that you can put your food in different places in the oven and still cook them at the same time. You can use the "Fan Bake" function for multi-shelf cooking, reheating cooked foods, pastries and complete oven meals. It will cook at a lower temperature and be faster than baking. Please note that some variation in browning is normal.

#### Bake/Pizza

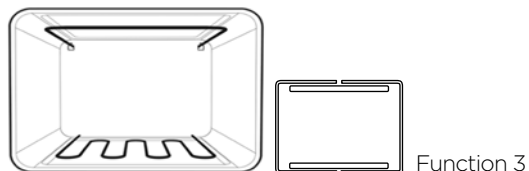

Heat comes from two elements, one above and one below the food. The bottom element is a clean heat element and is below the floor of the oven. Both elements are controlled by the thermostat and will turn on and off to maintain the set temperature. You can use the "Bake" function for pizza and single trays of biscuits, scones, muffins, cakes, slices, casseroles, baked puddings, roasts and delicate egg dishes.

### Base Heat

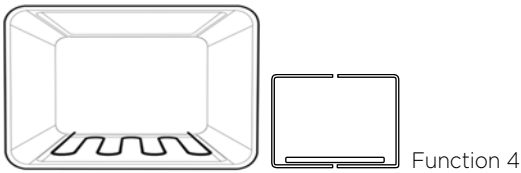

Heat comes from the element below the floor of the oven. The Element is controlled by the thermostat and will turn on and off to maintain the set temperature. The “Base Heat” function can be used to add extra browning to the bases of pizzas, pies and pastries. Cook in the lower half of the oven when you are using only one shelf. For best results, use silver or shiny trays.

### Fan Assist

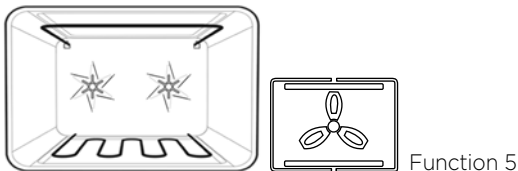

Heat comes from two elements, one above and one below the food. The fans circulate the hot air around the oven cavity so that you can put the food in different places in the oven and still cook them at the same time. You should only use a maximum of 2 shelves with “Fan Assist”. Do not use the bottom shelf. If two shelves are used, food on the shelf in the higher position will cook first and should then be removed to allow the food on the lower shelf to finish cooking.

### Pizza

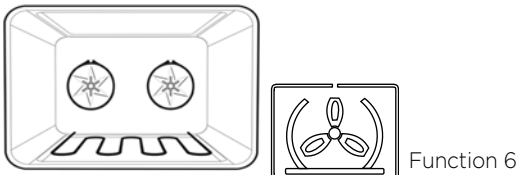

“Pizza” is a combination of “Base Heat” and “Fan Bake” and offers you the combined benefits of both functions. Heat comes from the elements surrounding the fans as well as the clean heat element below the oven floor.

The “Pizza” function is ideal for foods that require cooking and browning on the base. It is great for foods such as pizzas, quiches, meat pies and fruit pies. Simply place the food in the middle of the oven and set the desired temperature.

### Eco cooking

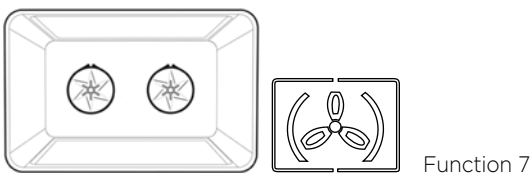

For energy saving baking and cooking on one shelf position. Gentle heat comes from the elements surrounding the fans. The lamps deactivate after 30 seconds.

### Defrost

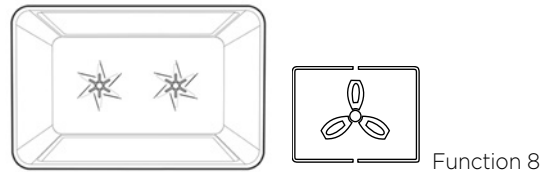

The “Defrost” function uses low temperature air that is circulated by the fans. You can defrost (thaw) your food before you cook it. You can also use “Defrost” to raise your yeast dough and to dry fruit, vegetables and herbs.

### Fan Grill

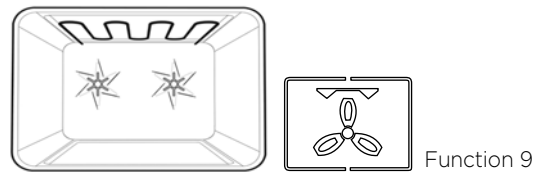

“Fan Grill” offers you the benefits of both “Bake” and traditional “Grill” functions. The grill element turns on and off to maintain the set temperature while the fans circulate the heated air. The oven door remains closed for fan grill. You can use “Fan Grill” for large cuts of meat to give you a result that is similar to “roisserie” cooked meat. Put your food on a shelf in the second lowest shelf position. Put the grill dish on the lowest shelf position to catch any spills. When using “Fan Grill” it is not necessary to turn the food over during the cooking cycle. Set the temperature to 180°C.

### Grill

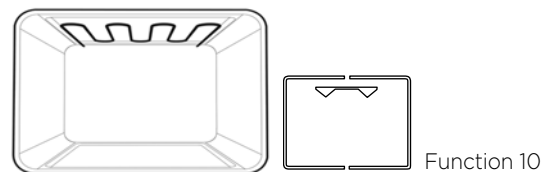

The “Grill” directs radiant heat from the powerful upper element onto the food. You can use the “Grill” function for tender cuts of meat, steak, chops, sausages, fish, cheese toasties and other quick cooking foods. Grill with the oven door closed. Preheat your grill for 3 minutes to get the best results. This will help seal in the natural juices of steak, chops etc. for a better flavour. You can slide your grill dish into either of the 2 spaces within the upper pairs of support rails.

### Maxi Grill

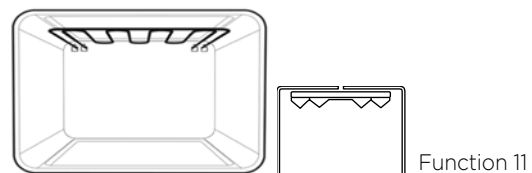

“Maxi Grill” directs radiant heat from 2 powerful upper elements onto the food. You can use the “Maxi Grill” function for tender cuts of meat, steak, chops, sausages, fish, cheese toasties and other quick cooking foods. Grill with the oven door closed. “Maxi Grill” allows you to take full advantage of the large grill dish area and will cook faster than normal “Grill”. For best results it is recommended to preheat your grill for 3 minutes. This will help seal in the natural juices of steak, chops etc. for a better flavour. You can slide your grill dish into either of the 2 spaces within the upper pairs of support rails.

## USING YOUR OVEN

### Pyro Clean (WVEP916SB & WFEP915SB models only)

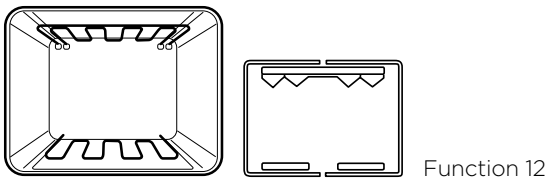

The “Pyrolytic cleaning” function is used for cleaning the main oven. It cleans by burning off the spatters and temperature. This process produces ash which can be wiped out of the oven cavity.

### Fast Heat Up

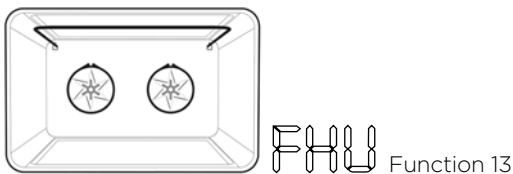

“Fast Heat Up” can be selected in the initial heat up phase of any cooking function. During “Fast Heat Up” the heat comes from the elements surrounding the fans as well as the smaller element above the food. This allows you to preheat your oven 30% quicker than on standard “Bake/Pizza”. See Using your programmable controller to operate the oven instructions for more information.

### Cooling/Venting fan

Your built-in appliance is fitted with a cooling fan. This prevents your kitchen cabinet from overheating and reduces the condensation inside the oven. It will operate whenever you are using your oven or grill and will blow warm air across the top of the oven door. In some appliances the cooling fan may continue to operate after the appliance is turned off. It will switch off by itself once oven is cool

### Condensation

Excess condensation may fog the oven door. This may happen when you are cooking large quantities of food from a cold start. You can minimise condensation by:

- Keeping the amount of water used whilst cooking to a minimum.
- Making sure that the oven door is firmly closed.
- Baking custard in a baking dish that is slightly smaller than the water container.
- Cooking casseroles with the lid on.

*NOTE: If you are using water in cooking, this will turn to steam and may condense outside your appliance. This is not a problem or fault with your oven.*

### Operating your oven temperature and function selectors model WFE914SB & WVE914SB

To set the oven, turn the function selector to the desired cooking function and then turn the temperature

selector to the desired temperature. An indicator light above the temperature selector will come on. When the temperature is reached the heating source switches itself off and the indicator light goes out. When the oven temperature falls below the desired setting, the heating source switches on and the indicator light comes on again.

Once the food is cooked, turn the temperature selector off in an anti-clockwise direction. Do not force it right round in a clockwise direction as this will result in damage to the thermostat. Turn the multifunction selector off.

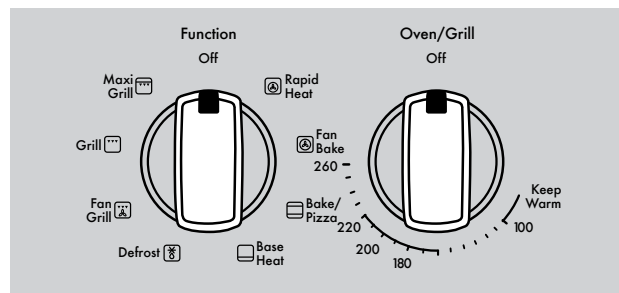

### Preheating your oven with “Rapid Heat”

To preheat your oven select the “Rapid Heat” function. This function allows your oven to reach the preset temperature quicker than any other cooking function.

1. Turn the function selector to “Rapid Heat”.
2. Set the desired preheat temperature, by rotating your oven temperature selector. When the indicator light above the temperature selector goes out, the oven has reached the desired temperature. Select the oven function you require for cooking or baking and place the food in the oven.

### On completion of cooking

- The heat source will turn off, the timer will beep and the end time and/or cook time ‘indicators’ will flash.
- Even though the heating element turns off the oven will still retain substantial heat. This will continue to cook the food until it is removed or the oven cools down. If you do not plan on being present when the oven turns off, you should take this extra heating time into account.
- Turn the function and temperature controls to the off position.
- Press any button to stop the timer beeping.

### Adjusting the clock ⌚

- Press the **MODE** button until the clock ⌚ indicator begins flashing.
- Press the **■** or **+** buttons to change the time of day. 5 seconds after the last change, the clock ⌚ ‘indicator’ will disappear, confirming the time has been adjusted

## Operating the touch control clock models WFE914SB and WVE914SB



### General features

Your touch control clock has the following features:

- **Timer** – allows you to set a countdown time that will beep when the set time has elapsed.
- **Cooking duration** – You can set a cooking duration. A timer will count down the preset cooking time, beep when the time has elapsed and turn the oven off.
- **End cooking time** – you can set a cooking finish time. A timer will count down the preset cooking time, beep when the finish time has been reached and turn the oven off.
- **Delayed start cooking time** – You can combine the cooking time and stop cooking time to switch the oven on and off at a specific time during the day.

*NOTE: Your touch control clock only operates with your main oven.*

### Setting the time of day

You must set the time of day before you can operate your appliance. When power is supplied to your oven “12.00” will be displayed and the “**clock**” indicator **I** will flash.

1. To set the time of day in hours and minutes, press **■** or **+**. 5 seconds after the last change, the “**clock**” indicator **I** will disappear, confirming the time has been set.

*NOTE: The clock has a 24-hour display.*

### Change the time of day (Daylight saving)

1. Press “**mode**” until the “**clock**” indicator **I** begins flashing.
2. Press **■** or **+** to change the time. 5 seconds after the last change, the “**clock**” indicator **I** will disappear, confirming the time has been set.

### Setting the timer

1. Press “**mode**” until the “**timer**” indicator **I** begins flashing.
2. Set the countdown time you want by using **■** and **+**. 5 seconds after the last change the “**timer**” indicator **I** will stop flashing, confirming the timer has been set.
3. To stop the beeper, press **■**, **+** or “**mode**”.

### Setting the cooking duration

1. Check the clock displays the correct time of day.
2. Select the desired oven function and temperature. The oven indicator light will glow and the heating source will come on.

3. Press “**mode**” until the “**cook time**” indicator **I** begins flashing.
4. Set the cooking duration you want by using **■** or **+**. 5 seconds after the last change, the “**cook time**” indicator **I** will stop flashing, and the time of day will be displayed.

*NOTE: Do not forget to add preheating time if necessary.*

### Setting the cooking end time

1. Check the clock displays the correct time of day.
2. Select the desired oven function and temperature. The oven indicator light will glow and the heating source will come on.
3. Press “**mode**” until the “**end time**” indicator **I** begins flashing.
4. Enter the time of day you want to finish cooking by pressing **■** or **+**. 5 seconds after the last change, the “**end time**” indicator **I** will stop flashing and the current time of day will be displayed.

### Setting the delayed start cooking time

1. Program the “**cook time**” and “**end time**” as described in the relevant sections. Once both the “**cook time**” and “**end time**” have been set, the “**cook time**” and “**end time**” indicators will stop flashing and the current time of day will be displayed.

### To check or cancel settings

1. To check your settings, press “**mode**” until the setting you want is displayed. A red light will flash next to the mode (cook time, end time etc) that is currently on display.
2. To cancel “**delayed start**” press “**mode**” until a light flashes next to “**cook time**”. Press and hold **■** until the clock no longer reverses (“0:00” and you will hear a beep). If you have left the temperature and function knobs at a setting the oven will start once the “**end time**” light stops flashing.
3. To cancel “**auto off**” press “**mode**” until a light flashes next to “**cook time**”. Press and hold **■** until the clock no longer reverses (“0:00” and you will hear a beep). This automatically cancels “**delayed start**”. If you have left the temperature and function knobs at a setting, the oven will start once the “**cook time**” light stops flashing. Because you have cancelled “**auto off**” the oven will continue to heat until you manually turn it off.

### On completion of cooking

The oven will turn off, the timer will beep and the “**end time**” and/or “**cook time**” indicators will flash.

1. Turn the function and temperature controls to the off position.
2. Press **+** or **■** or “**mode**” to stop the timer from beeping.

# USING YOUR OVEN

## Switching the clock display ON and OFF

1. Press together **+** and **■** for 2 seconds to switch 'off' the display.
2. Press together **+** and **■** for 2 seconds to switch the clock display 'on' again.

*NOTE: If a timer mode is set, then it is not possible to switch the display off.*

## Operating the Programmable Controller (WVEP916SB, WVE916SB, WFEP915SB & WFE946SB)

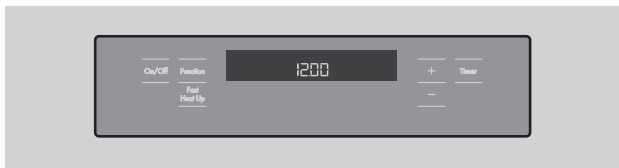



(WFE916SB)

### General features





The oven is equipped with a programmable controller that can be used to turn the oven on and off automatically. The **"Cook time"** function automatically turns the oven off after a set amount of time. The **"End time"** function is used to set the time of day you want the cooking cycle to finish. A **"Delayed start"** is possible by combining the **"Cook time"** and **"End time"** features to switch the oven on and off at a specific time during the day.

### Setting the time of day (after electrical connection)

1. After the appliance has been electrically connected, the **"Set clock"** symbol  will flash on the display.
2. To set the time of day, press **■** or **+** symbols while the **"Set clock"** symbol  is flashing.
3. After 5 seconds from the last change, the **"Timer arrow"** symbol  will disappear confirming the time has been set.

*NOTE: The clock has a 24-hour display.*

### Changing the time of day

1. Switch the appliance **"Off"** by pressing **"On / Off"**.
2. Press **"Timer"** button repeatedly until the **"Set clock"** symbol  appears flashing with the **"Timer arrow"** symbol  on the display.
3. To set the time of day, press **■** or **+** symbols while the **"Set clock"** symbol  is flashing.
4. After 5 seconds from the last change, the **"Set clock"** symbol  and **"Timer arrow"** symbol  will disappear, confirming the time has been set.

## Setting the oven function

1. Switch the appliance **"On"** by pressing **"On / Off"**. The oven light will turn on.
2. Press **"Function"** button repeatedly until the desired oven function appears. The suggested cooking temperature for that function will appear in the display which can be changed as described below. After 5 seconds from the last change, the oven will begin to heat.





*NOTE: If the oven temperature is less than the set temperature, the oven temperature and a rising thermometer icon is displayed. When the oven temperature reaches the set temperature, 4 beeps sound and the set temperature and full thermometer icon are displayed. If the set temperature is less than the oven temperature, the set temperature and a full thermometer icon is displayed.*

## Changing the oven temperature

1. Press **■** or **+** symbols to decrease or increase the temperature setting. The temperature setting changes in increments of 5°C.





*NOTE: The temperature can be adjusted at any time. Oven temperature cannot be changed for the Defrost function. For model WVEP916SB & WFEP915SB, oven temperature cannot be changed for the Pyro (PI) function.*

## Setting the cooking duration

1. Select the desired oven function and cooking temperature.
2. Press **"Timer"** button repeatedly until the **"Cook time"** symbol  appears flashing with the **"Timer arrow"** symbol  on the display.
3. Set the desired cooking duration by pressing **■** or **+** symbols while the **"Timer arrow"** symbol  is flashing.
4. After 5 seconds from the last change, the **"Timer arrow"** symbol  will disappear confirming the cooking duration is set.

*NOTE: Do not forget to add pre-heating time if necessary.*

## Setting the cooking end time









1. Select the desired oven function and cooking temperature.
2. Press **"Timer"** button repeatedly until the **"End time"** symbol  appears flashing with the **"Timer arrow"** symbol  on the display.
3. Set the desired time of day to finish cooking by pressing **■** or **+** symbols while the **"Timer arrow"** symbol  remains flashing.
4. After 5 seconds from the last change, the **"Timer arrow"** symbol  will disappear confirming the cooking end time is set.

### Setting the delayed start cooking time

1. Program the “**Cook time**” and “**End time**” as described in the relevant sections. Once both the “**Cook time**” and “**End time**” have been set, the “**Cook time**” and “**End time**” indicators will stop flashing and the “**Set temperature**” will be displayed.



*NOTE: Do not forget to add pre-heating time if necessary.*

### To check or cancel settings

1. To check your settings, press “**Timer**” until the setting you want to check is displayed.
2. To cancel “delayed start” press “**Timer**” until “**End time**” symbol  appears flashing with the “Timer arrow” symbol . Press and hold  symbol until the clock no longer reverses (“0:00” and you will hear a beep). If the oven “**Function**” is set, the oven will start once the “**Timer arrow**” symbol  stops flashing.
3. To cancel “auto shut off” press “**Timer**” until “**Cook time**” symbol  appears flashing with the “**Timer arrow**” symbol . Press and hold  symbol until the clock no longer reverses (“0:00” and you will hear a beep). This automatically cancels “delayed start” and if the oven “**Function**” is set, the oven will start once the “**Timer arrow**” symbol  stops flashing. Because you have cancelled “auto shut off” the oven will continue to heat until you manually turn it off.









### On completion of cooking

When the set time has elapsed, the oven will turn off and a beeper will sound for 1 minute. The remaining time indication “0:00” will appear on the display.

1. Press  or  symbols to stop the clock from beeping.

### Setting the minute minder



The minute minder can be used with the oven on or off.

1. Press “**Timer**” button repeatedly until the “**Minute minder**” symbol  appears flashing with the “**Timer arrow**” symbol .
2. Set the countdown time by pressing  and  symbols.
3. After 5 seconds from the last change, the “**Timer arrow**” symbol  will stop flashing confirming it has been set.
4. Once the set time has elapsed, a beeper will sound for 1 minute. The time indication “0:00” and a flashing “**Minute minder**” symbol  will appear on the display.
5. Press  or  symbols to stop the clock from beeping.

*NOTE: This feature has no effect on the oven operation.*

### Using FHU (Fast Heat Up) mode

To quickly and efficiently pre-heat your oven, it is recommended to select the “Fast Heat Up” cooking feature.

1. Ensure the appliance is on by pressing “**On/Off**”.
2. Press “**Function**” button repeatedly until the desired oven function appears.
3. Press  or  symbols to decrease or increase the temperature setting.
4. Press “**Fast Heat Up**” and the letters “FHU” will appear and alternate with “Oven temperature” on the display.
5. When the oven temperature reaches the set temperature, 4 beeps sound and the set temperature and full thermometer icon are displayed.

*NOTE: “Fast Heat Up” cannot be selected if the oven temperature is above the set temperature.*

### Activating the child-proof lock

When the child lock is activated, the oven cannot be switched on.

1. Switch off the appliance using “**On/Off**”.
2. Press and hold “**Function**” and  symbol at the same time until the word “SAFE” appears on the display. The child-proof lock is now engaged.

*NOTE: When the child-proof lock function is activated, only the time of day and minute minder can be set. For model WVEP916SB & WFEP915SB, the oven door is also locked when the child lock is activated.*

### De-activating the child-proof lock

1. Press and hold “**Function**” and  symbol at the same time until the word “SAFE” is cleared from the display. The child-proof lock is now disengaged and the oven is ready to use.

### Beep on touch

The “beep on touch” mode can be activated to sound anytime a button is pressed.

1. Switch the appliance “Off” by pressing “**On / Off**”.
2. Press and hold “**Function**” and  symbol at the same time. A single beep confirms mode is activated.
3. Repeat the procedure to de-activate.

*NOTE: “On / Off” will continue to “beep on touch” when mode is de-activated.*

## USING YOUR OVEN

### Safety cut-out feature

The oven will automatically switch “Off” if the temperature is not adjusted or the appliance is left operating for a period of time. The oven switches itself off after:

1. 20 hours when the temperature is set between 30°C and 120°C
2. 8.5 hours when the temperature is set between 120°C and 200°C
3. 5.5 hours when the temperature is set between 200°C and 250°C

### DEMO mode

The oven can be set to operate in a demo (e.g. in a retail store) mode. In this mode the oven does not actually heat if the oven has been inadvertently supplied in this mode. The following instructions demonstrate how to exit this mode.

1. Ensure the oven is “Off”. Press and hold the **+** button until a beep sounds. The ‘Demo’ text on the display will flash.
2. While holding the **+** button, turn the **Function** selector to the first oven function until another beep is heard.
3. Then turn the **Function** selector to the ‘Off’ position.
4. Release the **+** button.
5. Toggle and hold the **Temperature** selector to the right (**+**) until 3 beeps sound. The ‘Demo’ text will no longer be displayed and the oven will function normally. If the ‘Demo’ text is still displayed repeat the above procedure.

## COOKING TEST

### Get to know your new oven with this ‘Simple Test Cake’

Although we strive for a perfect performing oven, it’s possible that there will be some variation in colour when baking. Therefore, we suggest this simple, easy and delicious to make Simple Test Cake, it can help you understand your new oven. All ovens do sometimes have hot or cold spots, therefore it is important to judge with your eye as you may require to rotate during baking.

### ‘Simple Test Cake’

125g butter, softened to room temperature

1 cup caster sugar

1 teaspoon pure vanilla essence

4 large eggs

2 cups self-raising flour

pinch of salt

4 tablespoons (80ml) full-cream milk

### Method:

1. Butter base and sides of two 20cm straight-sided round or square cake pans. Then line the base with grease proof or baking paper.
2. Preheat oven to moderate ‘180°C’ (170°C fan forced) and ensure oven shelf is in the centre position of oven.
3. Cream softened butter and sugar until light in colour.
4. Add vanilla essence.
5. Then eggs one at a time, beating well after each addition.
6. Sift flour and salt into the mixture and beat until well combined.
7. Add milk and beat or stir to combine.
8. Spoon mixture equally between prepared cake pans.
9. Bake in preheated oven, middle shelf for about 25 to 35 minutes or until when tested with a fine cake skewer it comes out clean, or the edges of the cakes have come away slightly from the sides of the cake pans.
10. Remove from oven to wire cake rack and rest for 5 minutes before removing from cake pans. Cool completely.

To Serve: sandwich together with your favourite jam or conserve, and dust top with pure icing sugar.

*NOTE: If desired substitute butter for either margarine or olive oil spread. Recipe is based on the Australian standard metric 250ml cup and 20ml tablespoon sets.*

- For best baking results preheat oven for 30 minutes.
- Select the correct shelf location for food being cooked.
- The grill tray can be used in the oven as a baking dish, except in oven shelf location 1.



## COOKING GUIDE

- Make sure dishes will fit into the oven before you switch it on.
- Keep edges of baking dishes at least 40mm from the side of the oven. This allows free circulation of heat and ensures even cooking.
- Do not open the oven door more than necessary.
- Do not place foods with a lot of liquid into the oven with other foods. This will cause food to steam and not brown.
- After the oven is turned off it retains the heat for some time. Use this heat to finish custards or to dry bread.
- Do not use a lot of cooking oil when roasting. This will prevent splattering oil on the sides of the oven and the oven door. Polyunsaturated fats can leave residue which is very difficult to remove.
- When cooking things which require a high heat from below (e.g. tarts), place the cooking dish on a scone tray in the desired shelf position.
- For sponges and cakes use aluminium, bright finished or non-stick utensils.
- Remove unnecessary trays or dishes when roasting or baking.

### Oven shelf location

Your oven has seven positions for shelves. These are numbered from 1 (the lowest shelf position) to 7 (the highest shelf position). See diagram.

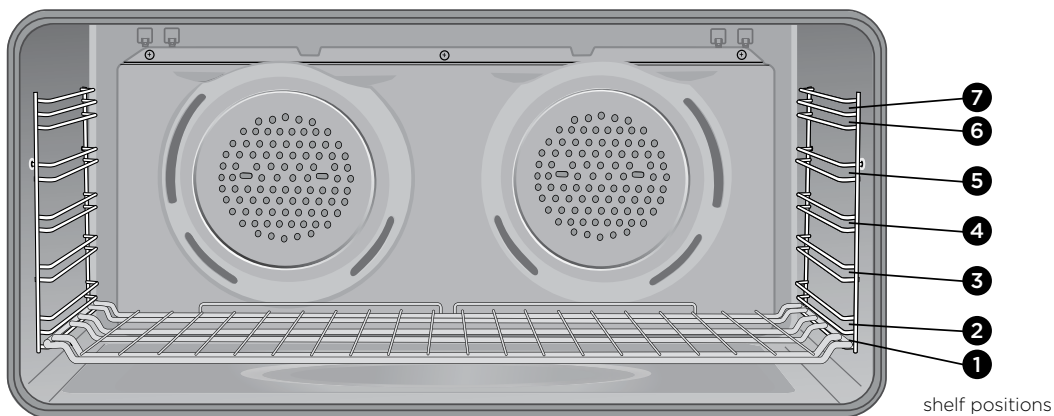

To give maximum space above and below the shelves, load them in this way:

- When cooking with 1 shelf, use position 3 or 4.
- When cooking with 2 shelves, use position 3 and 5.

Use the oven efficiently, by cooking many trays of food at the same time. For example:

- Cook 2 trays of scones, small cakes or sausage rolls.

# COOKING GUIDE

## Choosing the best oven settings

The following table is intended as a guide and experience may show some variation in cooking times necessary to meet individual requirements. We recommend that you preheat your oven for 30 minutes.

### Modes without oven fan

FOOD		TEMPERATURE °C	OVEN SHELF POSITION*	TIME IN MINUTES
Scones	Plain or fruit	220	3 or 4	10 - 15
Biscuits	Rolled	170	3	13 - 18
	Spooned	190	3	13 - 18
	Shortbread biscuits	160	3	30 - 35
Meringues	Hard - individual	110	3	90
	Soft - individual	180	3	15 - 20
	Pavlova - 6 egg	110	3	75
Cakes	Cup cakes	190	3 or 4	15 - 20
	Sponge - 4 egg	180	3 or 4	20 - 30
	Shallow butter cake	180	3	25 - 30
Pastry - short crust	Cornish pasties	200	3	40 - 45
	Custard tart	200/180	3	Pastry 8/200 Whole tart 10/200 & 20/180
Pastry - choux	Cream puffs	210	3	25 - 30
Yeast goods	Bread	210	3	25 - 30

### Modes with oven fan

FOOD		TEMPERATURE °C	OVEN SHELF POSITION*		TIME IN MINUTES
			SINGLE SHELF	MULTI SHELF	
Scones	Plain or fruit	210	3 or 4	2 & 5	10 - 15
Biscuits	Rolled	150	3 or 4	2 & 5	13 - 18
	Spooned	180	3 or 4	2 & 5	13 - 18
	Shortbread	150	3 or 4	2 & 5	13 - 18
Meringues	Hard - individual	100	3 or 4	2 & 5	90
	Soft - individual	165	3 or 4	2 & 5	15 - 20
	Pavlova - 6 egg	100	3 or 4	2 & 5	75
Cakes	Cup cakes	180	3 or 4	2 & 5	15 - 20
	Sponge - 4 egg	170	3 or 4	2 & 5	20 - 30
	Shallow butter cake	170	3 or 4	2 & 5	25 - 30
	Rich fruit cake	170	3 or 4	2 & 5	60
Pastry - short crust	Cornish pasties	180	3 or 4	2 & 5	40 - 45
	Custard tart	190/170	3 or 4	2 & 5	20 - 30
	Whole tart				Pastry 8/190 Whole tart 10/190 & 20/170
Pastry - choux	Cream puffs	200	3 or 4	2 & 5	25 - 30
Yeast goods	Bread	200	4	2 & 5	25 - 30

\* Counting from the bottom shelf up.

# COOKING GUIDE

## Roasting Meat

1. Place the meat in the oven and set the temperature between 180°C and 200°C. (It is recommended to wrap your meats in an oven roasting bag or foil to prevent fats and oils from splattering, making it easier to clean your oven.)
2. Use the grill/oven dish and grill insert. Place the meat on the insert.
3. Do not pierce the meat, as this will allow juices to escape.
4. When the meat is cooked, take the roast out of the oven, wrap in aluminium foil and leave to stand for about 10 minutes. This will help retain the juices when the meat is carved. The table shows temperatures and cooking times for different kinds of meat. These may vary depending on the thickness or bone content of the meat.

MEAT	RECOMMENDED TEMPERATURE	MINUTES PER KG	
Beef	180°C - 200°C	Rare	35 - 40
		Medium	45 - 50
		Well done	55 - 60
Lamb	180°C - 200°C	Medium	40
		Well done	60
Veal	180°C - 200°C	Well done	60
Pork	180°C - 200°C	Well done	60

## Roasting poultry and fish

1. Place the poultry or fish in an oven set at a moderate temperature of 180°C.
2. Place a layer of foil over the fish for about three quarters of the cooking time.

The table shows temperatures and cooking times for different kinds of fish and poultry. These may vary depending on the thickness or bone content of the meat.

POULTRY & FISH	RECOMMENDED TEMPERATURE	MINUTES PER KILOGRAM
Chicken	180°C - 200°C	45 - 50
Duck	180°C - 200°C	60 - 70
Turkey	180°C - 200°C	40 - 45 (<10kg)
		35 - 40 (>10kg)
Fish	180°C - 200°C	20

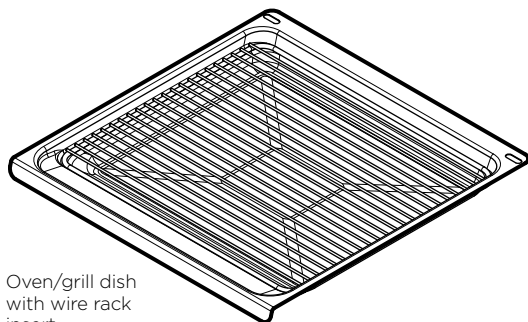

Oven/grill dish with wire rack insert

## Grilling Guide



### WARNING

Always clean the grill/oven dish after every use. Excessive fat build up may cause a fire.

### Grilling is conducted with the oven door closed

As a method of cooking, grilling can be used to:

- Enhance the flavours of vegetables, fish, poultry and meat.
- Seal the surface of the food and retain the natural juices.

This table shows how to grill different types of meat:

Beef	Tenderloin, rump, sirloin. Brush with oil or melted butter, especially if the meat is very lean.
Lamb	Loin chops, short loin chops, chump chops, and forequarter chops. Remove skin or cut at intervals to stop curling. Brush with oil or melted butter.
Sausages	Prick sausages to stop skin from bursting.
Poultry	Divide into serving pieces. Brush with oil.
Fish	Brush with oil or melted butter and lemon juice.
Bacon	Remove rind. Grill flat.

### Guide to better grilling

Steak	15 - 20 minutes
Chops	20 - 30 minutes
Fish	8 - 10 minutes
Bacon	4 - 5 minutes

No definite times can be given for grilling because this depends on your own tastes and the size of the food. These times should only be used as a guide and remember to turn the food over halfway through the cooking process.

For better grilling results, follow these easy instructions:

1. Preheat grill for at least 5 minutes.
2. Choose only prime cuts of meat or fish. If the cut is less than 5mm thick it will dry out. If the cut is more than 40mm thick, the outside may burn whilst the inside remains raw.
3. Do not place aluminium foil under the food as this prevents fats and oils from draining away, which could result in a fire.
4. Baste the food during cooking with butter, olive oil or marinade. Grilled food is better if marinated before cooking.
5. Use tongs to turn food as a fork pierces the surface and will let juices escape.

### Fan Grill

The "Fan Grill" assists the grilling process by circulating the heat evenly around the food. The recommended temperature setting is 180°C for all fan grilling functions.

1. Place the grill dish on the bottom rack.
2. Place meat/poultry on an oven shelf above the grill dish.
3. Wipe off any oil or fat which spatters while the oven is still warm.

## DEALING WITH COOKING PROBLEMS

(see also TROUBLESHOOTING)

PROBLEM	CAUSES	REMEDIES
Uneven cooking:	<ul style="list-style-type: none"> <li>• Incorrect shelf position.</li> <li>• Oven tray too large.</li> <li>• Trays not centralised.</li> <li>• Air flow in oven uneven.</li> <li>• Grill dish affecting thermostat.</li> </ul>	<ul style="list-style-type: none"> <li>- Select shelf that puts food in the centre of the oven.</li> <li>- Experiment with other trays or dishes.</li> <li>- Centre trays.</li> <li>- Rotate food during cooking.</li> <li>- Remove grill dish from oven on bake modes.</li> </ul>
Baked products too brown on top:	<ul style="list-style-type: none"> <li>• Oven not preheated.</li> <li>• Baking tins too large for the recipe.</li> <li>• Baking tins not evenly spaced.</li> <li>• Products not evenly sized or spaced on trays.</li> <li>• Baking temperature too high.</li> </ul>	<ul style="list-style-type: none"> <li>- Preheat the oven.</li> <li>- Use correct size tins.</li> <li>- Stagger baking tins at least 3cm between tins and the oven walls.</li> <li>- Make into same size and shape, &amp; spread evenly over trays.</li> <li>- Lower the temperature.</li> </ul>
Baked products too brown on bottom:	<ul style="list-style-type: none"> <li>• Baking tins too large for the recipe.</li> <li>• Baking tins are dark metal or glass.</li> <li>• Food too low in the oven.</li> <li>• Oven door opened too frequently during baking.</li> <li>• Baking temperature too high.</li> <li>• Grill dish affecting thermostat.</li> </ul>	<ul style="list-style-type: none"> <li>- Use correct size tins.</li> <li>- Change to shiny, light tins or lower the temperature by 10°C.</li> <li>- Cook one shelf higher.</li> <li>- Don't open the oven door until at least half the cooking time has passed.</li> <li>- Lower the temperature.</li> <li>- Remove grill dish from oven on bake modes.</li> </ul>
Cakes have a cracked, thick crust:	<ul style="list-style-type: none"> <li>• Baking temperature too high.</li> <li>• Food too high in oven.</li> <li>• Cake batter over mixed.</li> <li>• Pan too deep.</li> <li>• Baking pans dark.</li> </ul>	<ul style="list-style-type: none"> <li>- Lower the temperature.</li> <li>- Cook one shelf lower.</li> <li>- Mix just long enough to combine ingredients.</li> <li>- Check size of pan and use recommended size.</li> <li>- Change to shiny pans.</li> </ul>
Baked products are pale, flat and undercooked:	<ul style="list-style-type: none"> <li>• Baking temperature too low.</li> <li>• Food too low in oven.</li> <li>• Baking time too short.</li> <li>• Incorrect tin size.</li> </ul>	<ul style="list-style-type: none"> <li>- Raise the temperature.</li> <li>- Cook one shelf higher.</li> <li>- Increase cooking time.</li> <li>- Use correct size tin.</li> </ul>
Cakes fallen in the centre:	<ul style="list-style-type: none"> <li>• Baking temperature too low.</li> <li>• Baking time too short.</li> <li>• Proportions of ingredients incorrect in the recipe.</li> <li>• Opening door too early in baking.</li> </ul>	<ul style="list-style-type: none"> <li>- Raise the temperature.</li> <li>- Increase cooking time.</li> <li>- Check recipe.</li> <li>- Do not open the door until the last quarter of cooking time.</li> </ul>
Roast meat and potatoes not browning in fan oven:	<ul style="list-style-type: none"> <li>• Poor hot air circulation.</li> <li>• Grill dish affecting thermostat.</li> </ul>	<ul style="list-style-type: none"> <li>- Elevate food onto a rack to allow air circulation.</li> <li>- Remove grill dish from oven on bake modes.</li> </ul>
Juices running out of meat:		<ul style="list-style-type: none"> <li>- Do not pierce meat with fork, turn with tongs.</li> </ul>
Grilled meats overcooked on outside and raw in the centre:		<ul style="list-style-type: none"> <li>- Grill at lower insert position.</li> </ul>
Grilled chops and steaks curling:		<ul style="list-style-type: none"> <li>- Cut into fat every 2cm (1/2").</li> </ul>

# CLEANING YOUR APPLIANCE



## WARNING

- Always make sure that the oven is electrically isolated before cleaning. This can be done by the functional switch nearby.
- Do not line the bottom of the oven with foil or cookware.
- Do not use steam cleaners.

## Stainless steel



## WARNING

- The oven door trim, the control panel and the storage compartment are decorated with a special stainless steel that resists finger marks and should only be cleaned with warm water and a mild detergent. Do not use stainless steel cleaners, abrasive cleaners or harsh solvents on these parts.

*NOTE: Make sure you follow the polish or brushing lines in the stainless steel.*

- All grades of stainless steel can stain, discolour or become greasy. You must clean these regularly by following the procedures below if you want your appliance to look its best, perform well and have a long life.
- Care must be taken when wiping exposed stainless steel edges, they can be sharp!
- The stainless steel gas hob can be cleaned with stainless steel cleaners if it becomes soiled or discoloured.
- A suitable cleaner can be purchased from Electrolux Customer Care Centres.

## Glass

- Glass surfaces on doors and control panels are best cleaned immediately after soiling.
- A damp cloth may help remove baked on food deposits.



## WARNING

- The door glass on this appliance is made from a tough, durable material that withstands heating and cooling without breaking. However, it must be remembered that it is GLASS, it may break. Treat it accordingly! Should you have any questions about the glass in your new appliance, please contact the customer care centre by dialling 1300 363 640.
- Do not use harsh abrasive cleaners or sharp metal scrapers to clean the oven door since they can scratch the surface, which may result in the shattering of glass.

## Gas hotplate

- The trivets can be removed for cleaning by carefully lifting them from the hob.
- Clean by washing with warm soapy water.
- The burner caps and crowns are also removable for cleaning.
- If the caps, crowns and cups are heavily soiled, use a non-abrasive cleaning compound.
- Flame port blockages should be removed by using a matchstick or brush.
- Do not clean them with abrasive or caustic type cleaners, or clean them in a dishwasher.

## Ceramic hotplate

- Remove all spilled food and fat with the supplied razor blade scraper, while the ceramic glass is still warm but not hot. Wipe clean with dishwashing detergent on a damp cloth.
- If aluminium foil, plastic items or high sugar content foods are allowed to melt on the ceramic glass, clean immediately with the supplied razor blade scraper before the surface has cooled down, otherwise pitting of the surface can occur.

*NOTE: Items with high sugar content not only include jam and fruit, but also vegetables such as peas, tomatoes and carrots.*

- When the ceramic glass is cool, apply a suitable ceramic glass cleaner.
- It is important to follow the cleaner manufacturer's instructions. Remove any cleaning residue from the surface as staining of the cooktop may occur.
- Do not use abrasive sponges or scourers, as they may scratch the surface.
- Any pitting, staining, scratches or other surface deterioration is excluded from the warranty.
- Sometimes surface stains appear to be 'bubble' marks under the ceramic glass. These can be cleaned off with a razor blade scraper and ceramic cleaner.

## Oven

- Always keep your appliance clean. Ensure that fats and oils do not accumulate around elements, burners or fans.
- Always keep the oven dish, baking trays, grill dish and grill dish inserts clean, as any fat deposits may catch fire.
- Always wrap your meats in foil or an oven roasting bag to minimise cleaning. Any polyunsaturated fats can leave a varnish-like residue which is very difficult to remove.

## Grill

- Always keep the grill dish and grill dish insert clean, as any fat deposits may catch fire.

## CLEANING YOUR OVEN ACCESSORIES

### Removing the trays and shelves from your appliance

- Slide the dish and grill tray towards you until they reach the front stop.
- Tilt them up at the front to clear the side supports, taking care not to spill the contents.
- Lift them clear.
- Wash the tray and shelves in hot soapy water.
- Reverse the above steps to put the grill tray and shelves back again.
- Ensure that they are placed between the 2 support wires.

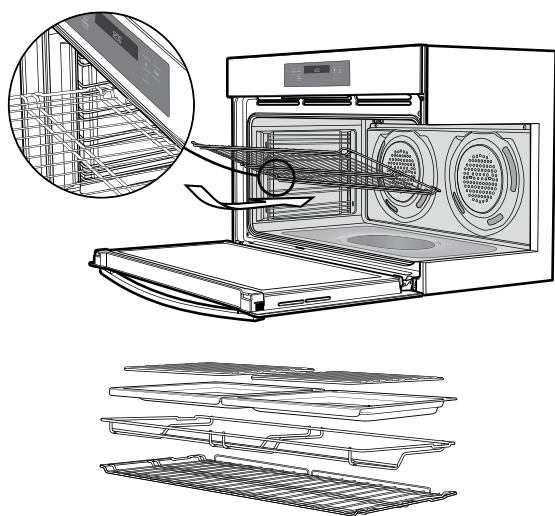

### Removing the side racks or shelf supports

- Grasp the shelf support at the front.
- Pull it firmly inwards

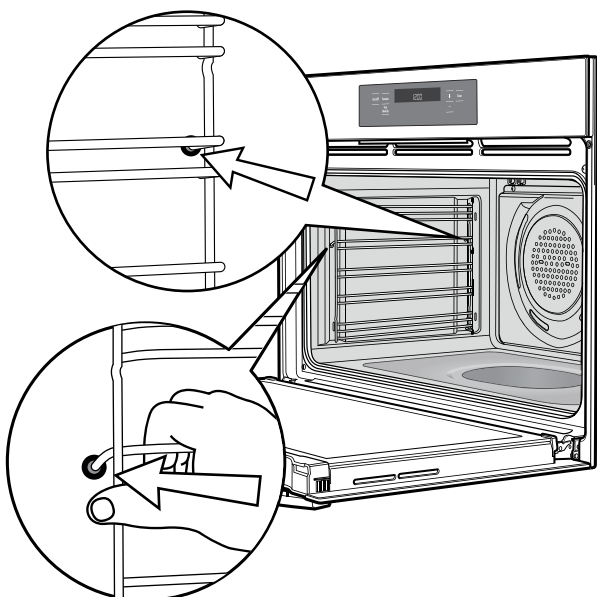

### Cleaning your oven door

The oven door has been designed to allow the two inner door glasses to be removed for cleaning without removing the door from the product.

Removing the inner door glass for cleaning:

- Open the door fully to gain access to the hinges.
- Push down the hinge locking tab as shown in the diagram on both sides of door.

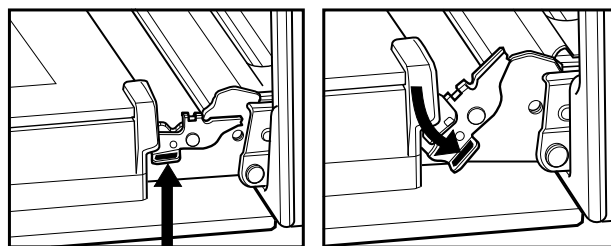

Locking tab up - normal position    Locking tab down - for cleaning

- Gently close the door until it stops in partially open position on the locking tab (the door will not fully close with the locking tab in the down position).
- In this position the top door trim can be removed by pushing each side on the serrated surface to release the clips and lift the trim away from the door.
- To remove the inner glass, tilt top of glass towards the oven and lift out.
- The middle glass is removed in the same way.
- The inner side of outer glass can be cleaned in-situ when inner and middle glass is removed.
- Clean glass using detergent and warm water, wipe clean and dry thoroughly.

Re-assembling the door glass panels:

- Replace the middle glass back to the door. The middle glass is a clear pane and orientation of the glass is not important.
- Replace the inner glass back to the door, ensuring the side with black ceramic paint faces away from the oven cavity when door is closed.
- Fully open the door and return the locking tabs to their normal position and close the door.

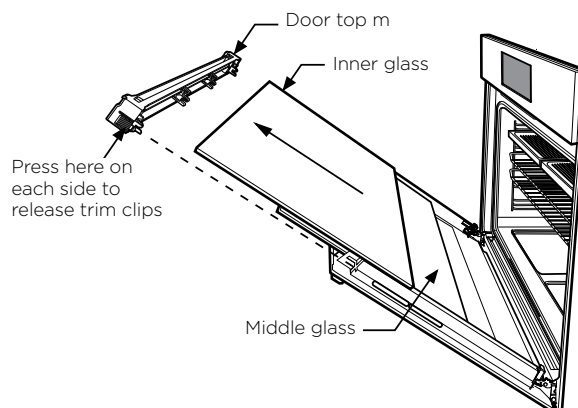

# CLEANING YOUR PYROLYTIC OVEN

## WVEP916SB & WFEP915SB

### Pyrolytic cleaning of the oven cavity

The oven has the Pyrolytic self-cleaning function, it cleans by burning off the spatters and accumulated dirt and grease from the oven liner, at high temperature. This process produces ash which can then be wiped out of the oven cavity. It is recommended you clean your oven regularly to keep the oven in its best condition.

- Light clean - this is an energy saving cycle that can be used on a regular basis if the oven is lightly soiled. Possibly after every 2nd or 3rd roast.
- Normal clean - use this as the regular cycle about once every 2-3 months.

### Before carrying out the Pyrolytic cleaning function



#### WARNING

- Clean large deposits, spills or grease from the oven cavity.
- Please keep small children at a safe distance. The appliance becomes very hot.
- Never clean non-stick baking trays and tins in the oven during the pyrolytic cycle. High temperatures damage the non-stick coating and poisonous gas is released.
- Pyrolytic cleaning can release fumes that are not harmful to humans, including infants or persons with medical conditions, however you are strongly advised to provide good ventilation during and after each pyrolytic cleaning process.
- Unlike humans, some birds and reptiles can be extremely sensitive to the potential fumes emitted during the pyrolytic cleaning process. It is strongly advised to remove any pets (especially birds) from the vicinity of the appliance during and after each pyrolytic cleaning process.
- Small pets can also be highly sensitive to the localized temperature changes in the vicinity of all pyrolytic ovens when the pyrolytic self cleaning program is in operation.



#### CAUTION

- All accessories must be removed from the oven, including shelves, trays and side racks.
- During pyrolytic cleaning the air outlet vent above the door must be kept clear of any obstruction (e.g. tea towels).
- Do not use your oven to clean miscellaneous items (e.g. cookware).
- To prevent damage, do not use acids, sprays or similar cleaning agents.



#### IMPORTANT

During the pyrolytic cleaning function, it is advisable not to use a cooktop if it is fitted above the oven. This could cause overheating and damage to both appliances. The cooling fan will operate at an increased speed for Pyrolytic cleaning and will continue to run until the oven has cooled down. It is recommended to use the Pyro clean function regularly to keep the oven in its best condition.

### Pyrolytic cleaning

- Switch on the appliance by pressing "On / Off".
- Press the "Function" button repeatedly until "P1" is displayed.
- Press the "-" or "+" symbols to choose between "1hrs 30 min" (light clean or "2hrs 30 min" (normal clean) for the appropriate level of cleaning.
- Press the "Pyro Accept" button to commence the cleaning process.
- The oven will begin heating and the "Remaining Time" will be displayed.
- The pyrolytic cleaning function can be stopped at any time during the cycle by pressing the "On / Off".

### During Pyrolytic cleaning

When the temperature in the oven approaches 300°C, the door will automatically lock and a padlock symbol will appear on the display.

### After Pyrolytic cleaning

The door will only unlock when the oven has cooled to a safe temperature. Turning the function off will not unlock the door.

After cool-down, wipe the ash out of the oven with a soft damp cloth and warm water. To restore the enamel shine to more difficult areas, use a damp cloth with vinegar and detergent.



#### CAUTION

Do not turn off the mains power supply to the oven during the pyrolytic cleaning cycle. This could damage the appliance.

# CLEANING YOUR OVEN ACCESSORIES

## Cleaning your oven door

### **WARNING**

- DO NOT use the oven without the inner and middle door glass fitted.
- NEVER spray any caustic cleaners on any surface of the door or damage to the surface coatings will result.
- DO NOT use metal utensils, scrapers, scourers, or abrasive cleaners to clean the glass or any of the door trims. These will damage or scratch the surface coatings and degrade the finish and appearance.
- DO NOT place glass in dishwasher.
- Use only warm water and liquid detergent with a soft cloth to clean the glass or trims.
- Before refitting the glass panes to the door ensure they are dried with a soft cloth.
- The glass edges have been specially ground to remove any sharp edges. However it is glass, and should be handled carefully to avoid injury to your person and damage to the glass.

### **WARNING**

Make sure the appliance power is switched off at the isolating switch before you remove or replace parts, to avoid the possibility of electric shock.

## Changing the light globes

- There are 2 light globes located in the top of the oven cavity towards the front. The light globe glass is accessible between the passes of the upper element.
- To remove, turn oven light glass anti-clockwise.
- A special high temperature resistant globe should be used. This can be purchased from the customer care centre.

## Storage compartment (selected models)

The storage compartment is accessible through the pivoting door.

Unused oven racks and grill dishes can be stored here.

### **WARNING**

DO NOT store flammable or combustible items in the storage compartments. This is not a compartment for warming food.

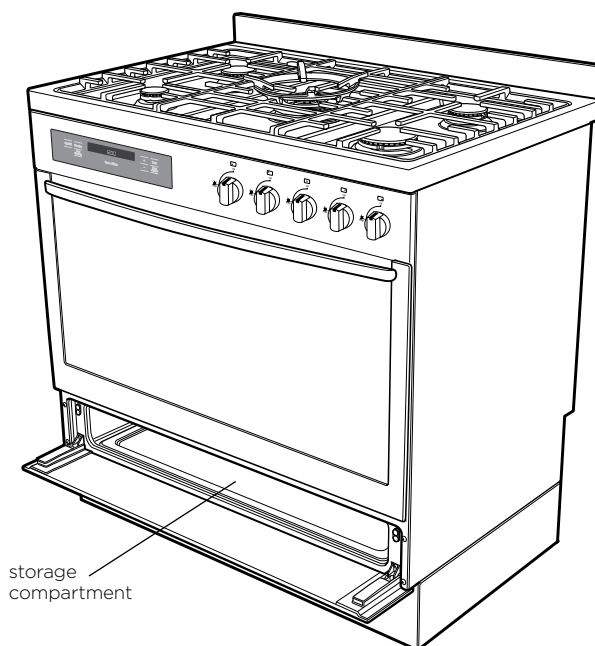



# TROUBLESHOOTING

## Faults

If there is a problem with the oven and/or grill, please:

- Check the points listed below before calling for service. It may be possible to avoid a call by fixing the problem yourself – and so continue cooking.

*NOTE: We may charge for service even in the guarantee period if your problem is due to the causes listed below.*

PROBLEM	POSSIBLE CAUSE	WHAT TO DO
Oven or grill not working	Power not turned on	Switch on electricity
	Household fuse blown	Check fuses
	Controls incorrectly set	Reset controls
	Circuit breaker tripped	Check circuit breaker
	Clock not set	Set time of day on timer
	Demo Mode 'ON' (for WFE946, WVE916, WVEP916 & WFEP915)	Deactivate DEMO Mode. Refer to 'Using your oven'
	Child Lock 'ON' (for WFE946 & WFE916)	Deactivate Child Lock. Refer to 'Using your oven'
Oven not heating enough	Foil or trays on bottom of oven	Remove foil or trays
Light & fans on continuously	Timer not in manual mode	Set timer to manual mode
Oven not working	Timer not in manual mode	Set timer to manual mode
	Household fuse blown	Check fuses
Oven light not working	Household fuse blown	Check fuses
	Circuit breaker tripped	Check circuit breaker
	Lamp blown or loose in socket	Replace or tighten lamp
Cooker smoking when first used	Protective oils being removed	Turn grill on high for 30 mins and then the oven on 220°C for 1 hour
Too much condensation building up when baking	Too much water used when cooking	Reduce amount of water
		Leave oven door open after cooking
Smells when first using oven	Protective oils being removed	This is normal
Timer flashing	Power failure or interruption	Reset time of day
Burner will not light even though the sparkers is working	Knob not held down long enough in 'High' position for flame safeguard (where fitted) to engage	Repeat lighting procedure and hold knob down for 5 seconds in 'High' position
	Gas supply valve turned off	Turn on gas supply to appliance
	Wrong knob turned off	Ensure the knob you are turning corresponds to the burner you wish to light
	Port blockage in ignition area	Ensure the ports in the ignition area are clean and dry
No spark is obtained when control knob is activated	Ignition spark plugs wet or dirty	Dry or clean ignition spark plugs
	Electricity supply is disconnected or switched off	Switch on electricity or check fuses
Flames uneven or tending to lift	Ignition spark plugs wet or dirty	Dry or clean ignition spark plugs
	Flame ports blocked or wet	Clean or dry flame ports
	Burner incorrectly fitted	Ensure this component is fitted correctly

*NOTE: Only authorised personnel should carry out servicing. If the household fuse continues to blow, call the Customer Care Centre. In the event of a power failure the gas burners may be lit with a hand held igniter and used. Take care to avoid letting unburnt gas flow for more than 5 seconds when attempting to light the burner.*

## TROUBLESHOOTING

PROBLEM	POSSIBLE CAUSE	WHAT TO DO
Flames not staying on when knob released	Knob not held down long enough in 'High' position for flame safeguard (where fitted) to engage	Repeat lighting procedure and hold knob down for 5 seconds in 'High' position
	Knob not set between 'High' and 'Low'	Knob MUST be set between these positions
	Dirt or spillage on flame safeguard sensor (where fitted)	Clean flameguard sensor tip
Low heat, slow cooking	Incorrect cooking pot or pan being used	Refer to cooktop section for correct selection
Benchtop or knobs overheating	Incorrect cooking pot or pan being used	Refer to cooktop section for correct selection
	Pot or pan not located on burner properly	Ensure pot or pan is centrally located on burner
Stains appear to be under ceramic glass	These marks are on the surface of the ceramic glass	Clean marks off with a razor blade scraper and ceramic glass cleaner.
Shelf or telescopic runner slides out when door is opened	Oven cavity is not level with the ground.	Perform a check using a level to verify cause (refer to installation section). If not level refer to installer.

### Further information

When you need information, service or replacement parts or have a warranty enquiry, please contact the Customer Care Centre:

- Australia - 1300 363 640, 8.00am - 5.00pm EST Monday to Friday
- New Zealand - 09 573 2384, 8.00am - 5.00pm EST Monday to Friday

Please have the following information ready: Model, Model Number & Serial Number. This is shown on the data plate which is visible when the oven door is open.

# INSTALLATION OF THE APPLIANCE

## installing splashback (Models with hob only)

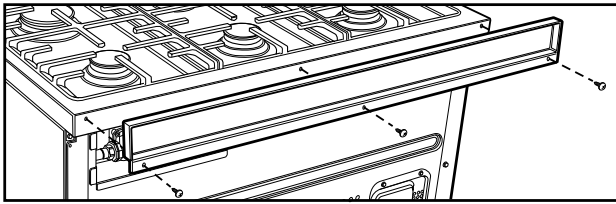

Fit splashback to rear of hob with three screws provided.

## Cabinet requirements

Models WFE914SB, WFEP915SB, & WFE946SB are designed to fit into a 900mm wide gap between standard kitchen cabinets. The appliance integrates with the kitchen cabinets by matching the height, depth and kick panel. The cooker may also be installed at the end of a line of benches or with a free space either side. In addition, a slot-in type installation is catered for allowing a continuous cabinetry kick panel to be used. Model WVE916 is designed to be built into cabinetry either below a benchtop or into a vertical cabinet.



## WARNING

- The cooker must be installed and serviced only by an authorised person.
- A Certificate of Compliance MUST be supplied to be kept by the customer.
- The packing materials must be removed before you install the cooker.
- The surrounding kitchen cabinets must be able to withstand 85°C. Electrolux WILL NOT accept responsibility for damage caused by installation into kitchen cabinets which cannot withstand 85°C.
- The pipes used for installation MUST have sufficient loops so the cooker can be moved for service (gas models).
- The vents, openings and air spaces MUST NOT be blocked.
- The anti-tilt brackets and chain or front stops MUST be installed to avoid accidental tipping (freestanding and slot-in models).
- You MUST NOT lift or pull the cooker by the door handle.
- The cooker MUST be checked every five years.
- If the supply cord is damaged, it must be replaced by the manufacturer, its service agent or similarly qualified persons in order to avoid a hazard.
- The appliance must not be installed behind a decorative door in order to avoid overheating.
- The unit must be pushed up against the wall on installation. On gas units check that the gas hose, if used, has not been kinked during installation.

## Levelling oven

Place a level in the oven as below making sure the level sits on the front and rear forms

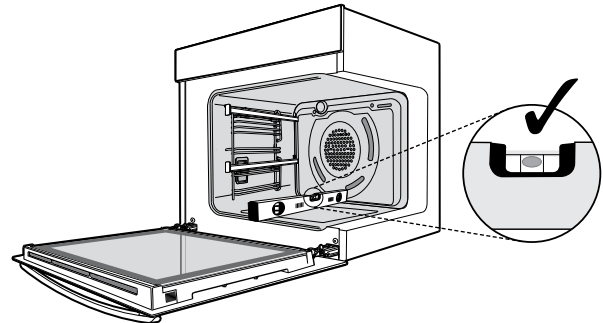

## Gas model clearance requirements Models WFE914SB and WFEP915SB

- Ensure the appliance is installed in accordance with clauses 6.2.5 and 6.10.1.1 of AS/NZS 5601.1 or clauses 6.9.1 and 6.9.5 of AS/NZS 5601.2 with regard to clearances to combustible surfaces and materials, and clearances to rangehoods and exhaust fans, to ensure clearances of 200mm from burners to vertical combustible surfaces observe the minimum dimension of 100mm from each side of the cooker to combustible surfaces.
- Clearances to combustible surfaces may be reduced if combustible surfaces are protected in accordance with clause 6.10.1.2 of AS/NZS 5601.1, or clause 6.9.2 of AS/NZS 5601.2.
- When setting the cooker height, ensure the top of the cooker is at least 10mm higher than the level of the benchtop.

## Dimensions

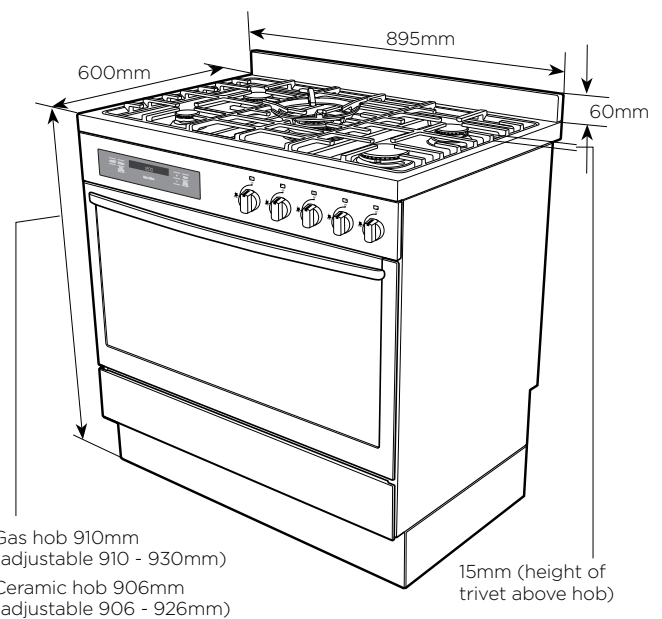

# INSTALLATION OF THE APPLIANCE

## Freestanding installation

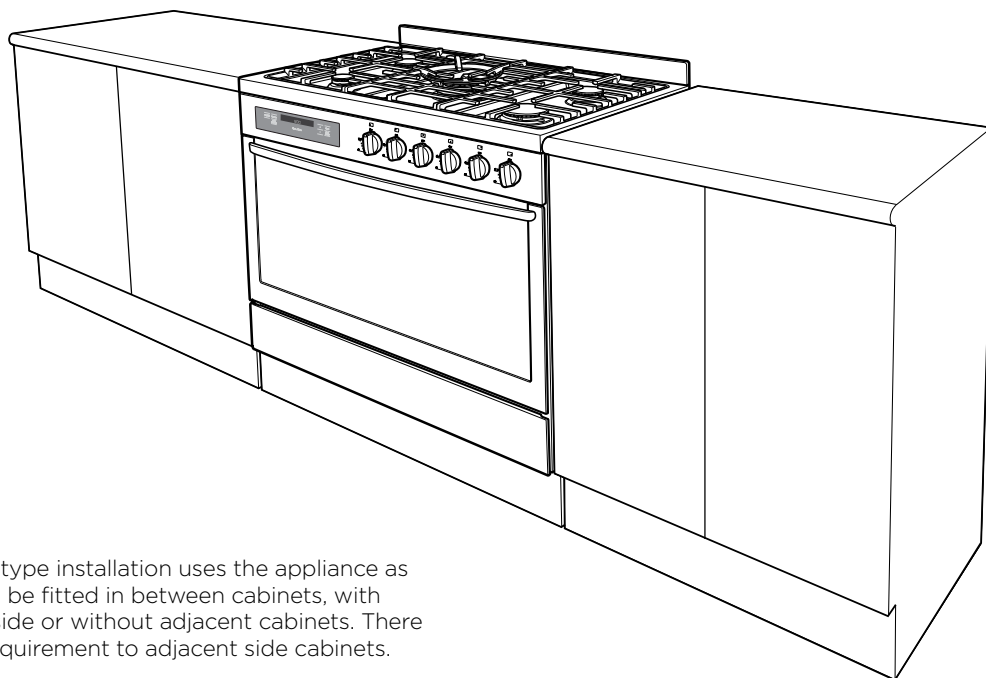

The freestanding type installation uses the appliance as supplied, and can be fitted in between cabinets, with cabinets on one side or without adjacent cabinets. There is no clearance requirement to adjacent side cabinets.

To ensure cooker stability, the anti-tilt brackets must be installed, and the end of chain attached to the appliance must be placed onto hook attached to the rear wall.

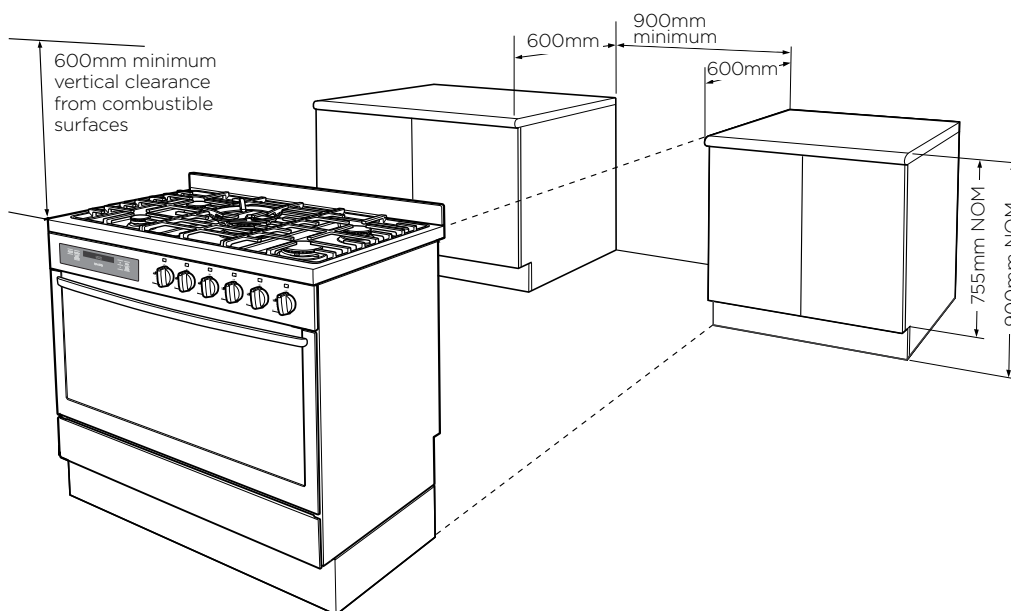

# INSTALLATION OF THE APPLIANCE

## Freestanding installation continued

### Installation of anti-tilt brackets and hook

- The anti-tilt brackets must be secured to the floor at rear of cavity with an appropriate fastener according to dimensions in diagram.

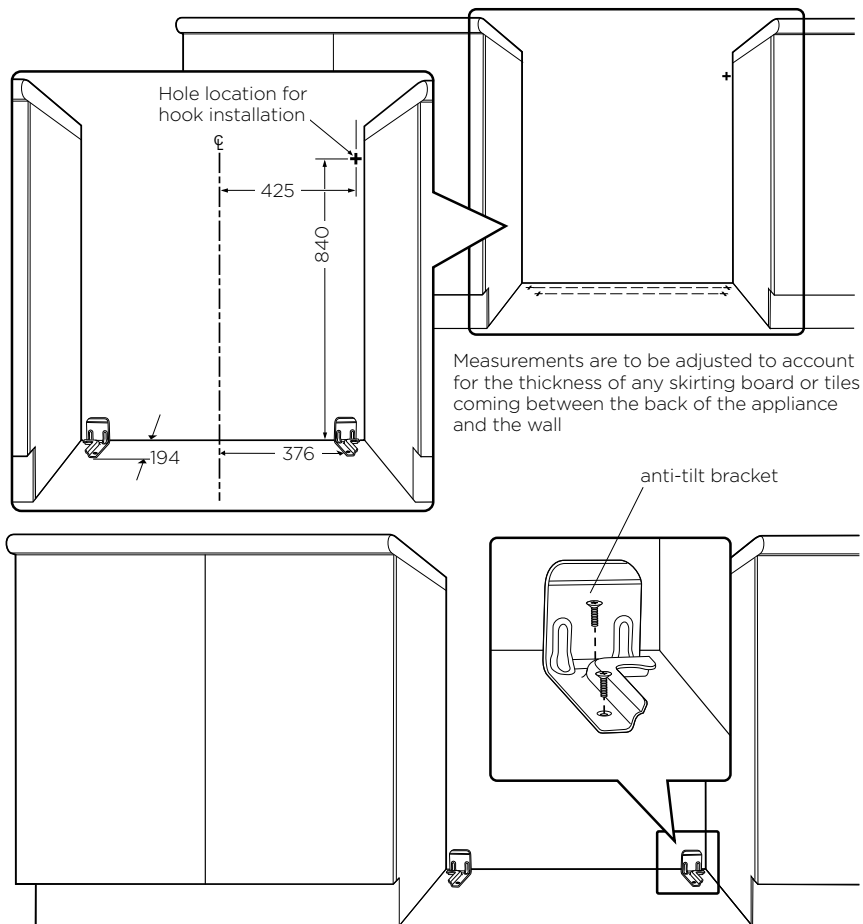

- Gas only: The hook is to be secured to the back wall in the location shown above with an appropriate fastener capable of withstanding a 10kg load (not supplied).
- Connect services to the appliance prior to placing into cavity.
- To locate appliance, slide into cavity and ensuring the rear left and right foot of appliance are captured by the anti-tilt brackets.
- Gas only: Before the appliance is fully pushed into position, place the chain attached to the rear of appliance onto the wall hook.

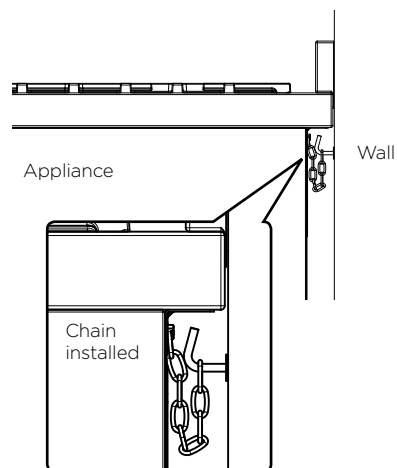

# INSTALLATION OF THE APPLIANCE

## Slot-in Installation

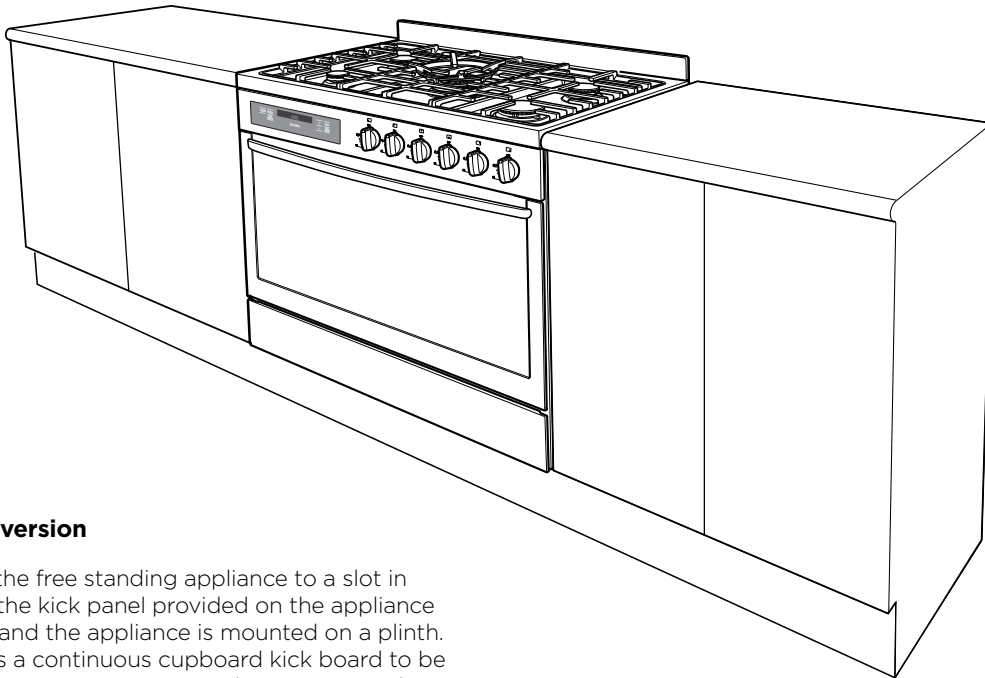

## Slot in conversion

To convert the free standing appliance to a slot in installation the kick panel provided on the appliance is removed and the appliance is mounted on a plinth. This enables a continuous cupboard kick board to be installed, giving a more integrated appearance. There is no clearance requirement between oven and adjacent side cabinets.

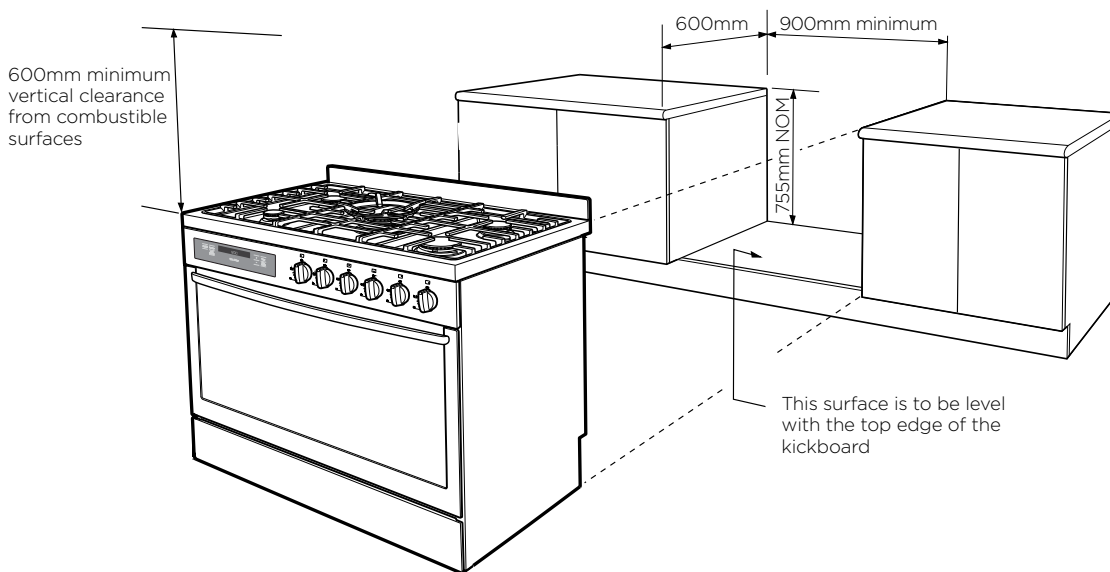

## To remove the appliance kick panel

- Remove all loose parts i.e. Burner crowns and caps, trivets, oven shelves.
- Carefully lay down the appliance onto one side onto foam packaging and remove the screws as shown from each corner bracket.

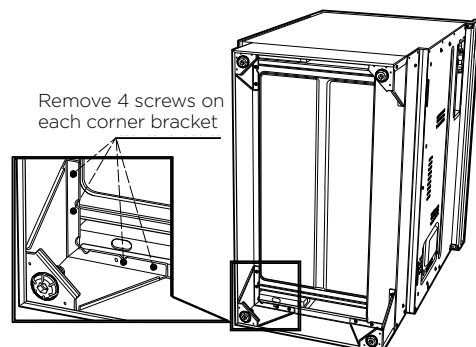

# INSTALLATION OF THE APPLIANCE

## Installation of anti-tilt brackets and stops

- The brackets are to be secured to the back wall with appropriate fasteners.
- The bottom edge of the brackets rest on the horizontal support surface.
- Two stops are to be screwed to the plinth in locations as shown (stops provided). The stops locate into slots in the base of the appliance to prevent the product from being pulled forward when installed.
- Measurements from the rear wall are to be adjusted if there are tiles etc. that come between the appliance and the wall.
- Once services are connected, product can be lifted onto the plinth and pushed back carefully, ensuring the appliance engages into both brackets at the rear and the front stops.
- If the product requires removal for service, it must be lifted at the front approximately 5mm to clear the front stops prior to being pulled forward.

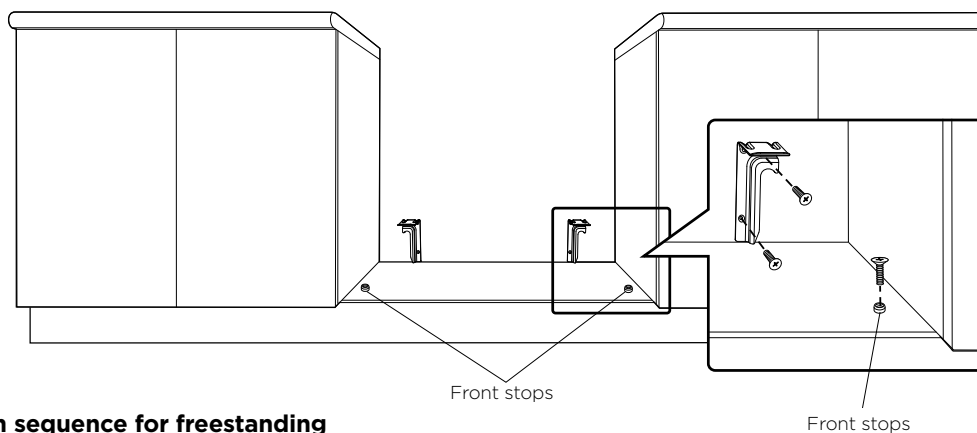
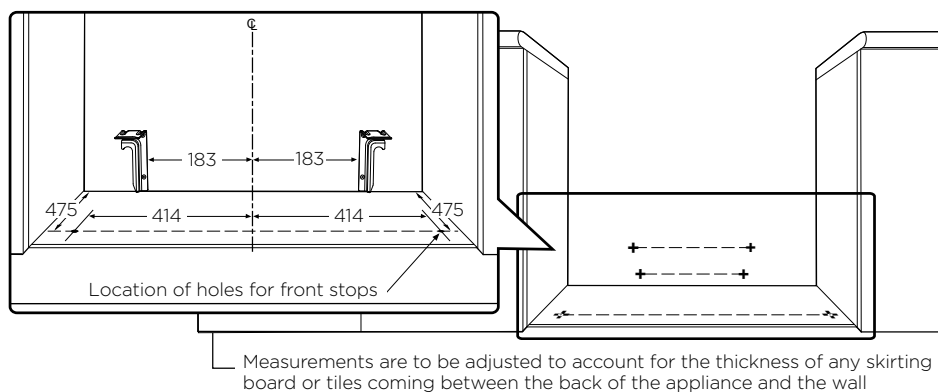

## Installation sequence for freestanding or slot in installation

- Check that the required services are correctly positioned (see electrical & gas services requirements).
- Ensure cabinetry has the correct details.
- Install anti-tilt brackets and chain hook or front stops as appropriate.
- Remove all packaging from cooker, remove all loose parts i.e. Trivets, burner crowns, oven shelves.
- Remove plastic film from cooker.
- Fit splashback to cooker.
- Slide cooker into position to check fitment to anti-tilt bracket. For freestanding installation, check the height and level of the cooker. Adjust cooker feet as required.
- Connect gas and electrical services.
- Place into position.
- Complete Certificate of Compliance.

# INSTALLATION OF THE APPLIANCE

## Cabinet construction for built in oven

For the best integration within a kitchen, install this appliance in a cupboard that gives a flush fit with the surrounding cupboard fronts. A recess of 20mm is ideal.

*NOTE: Your appliance must be mounted on a horizontal surface for the full width and depth of the product.*

*NOTE: A ventilation slot 20mm wide is required at the rear of the base of the cabinet floor.*

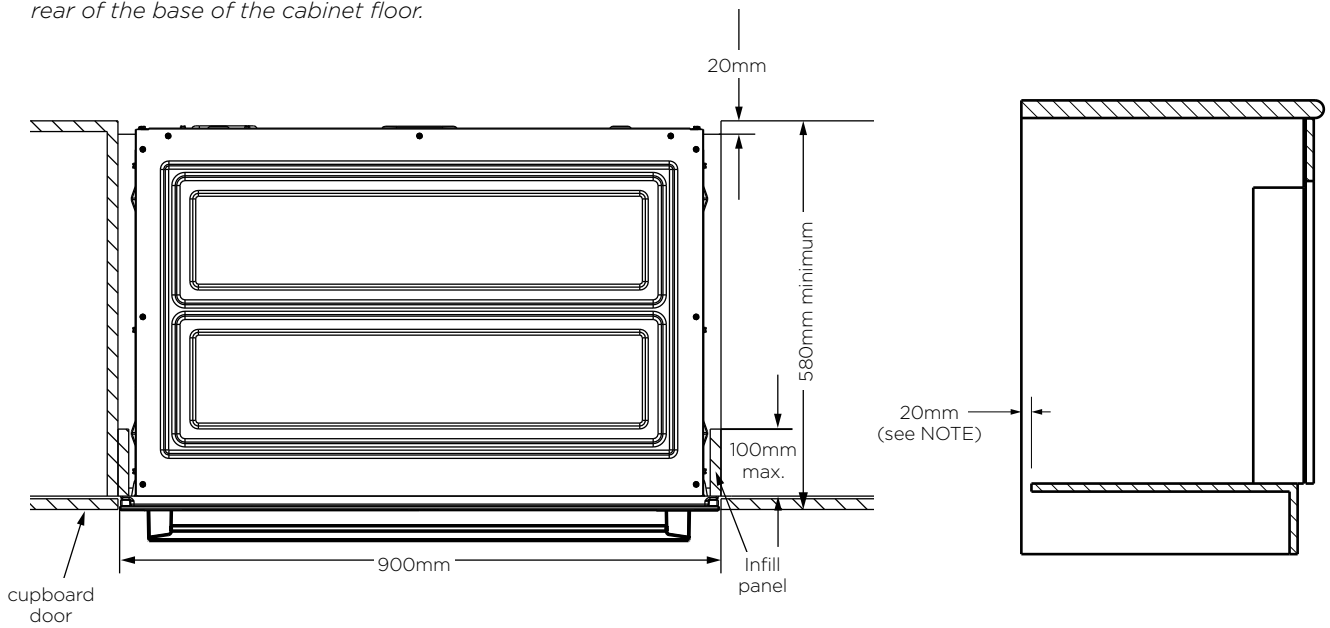

## Oven dimensions

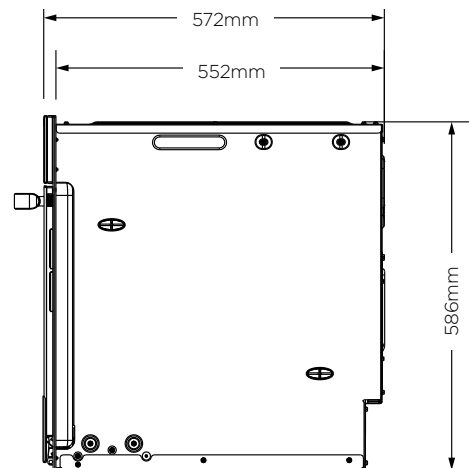
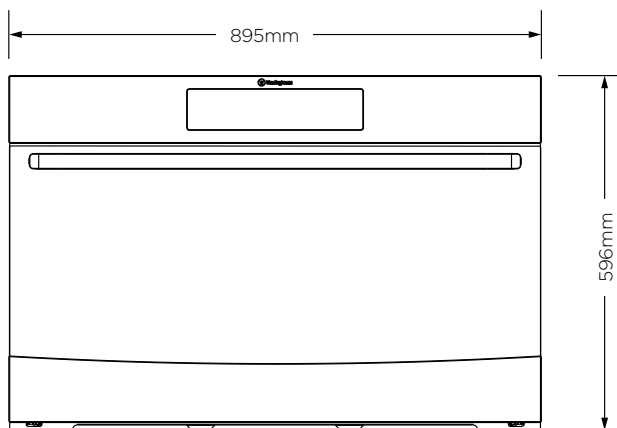



# INSTALLATION OF THE APPLIANCE

## Underbench installation

Your underbench oven looks best when the control panel is directly under the benchtop. An upper infill panel may be added if the cooktop placed above the benchtop is too deep.

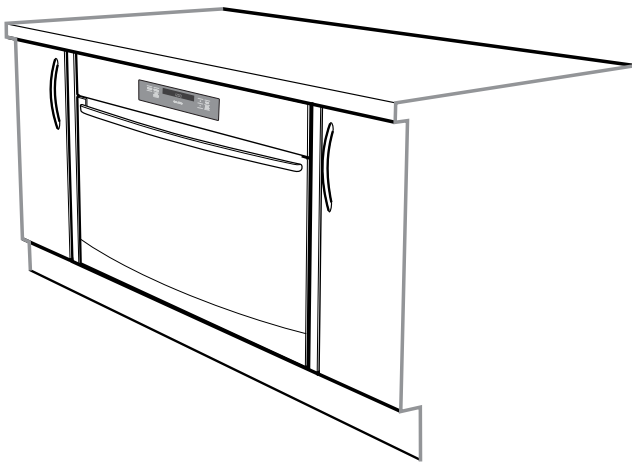

## Vertical cabinet installation

The oven can be built into a vertical cabinet in the same manner as an underbench. The required cavity dimensions are the same and the product is secured to the cabinet in the same way.

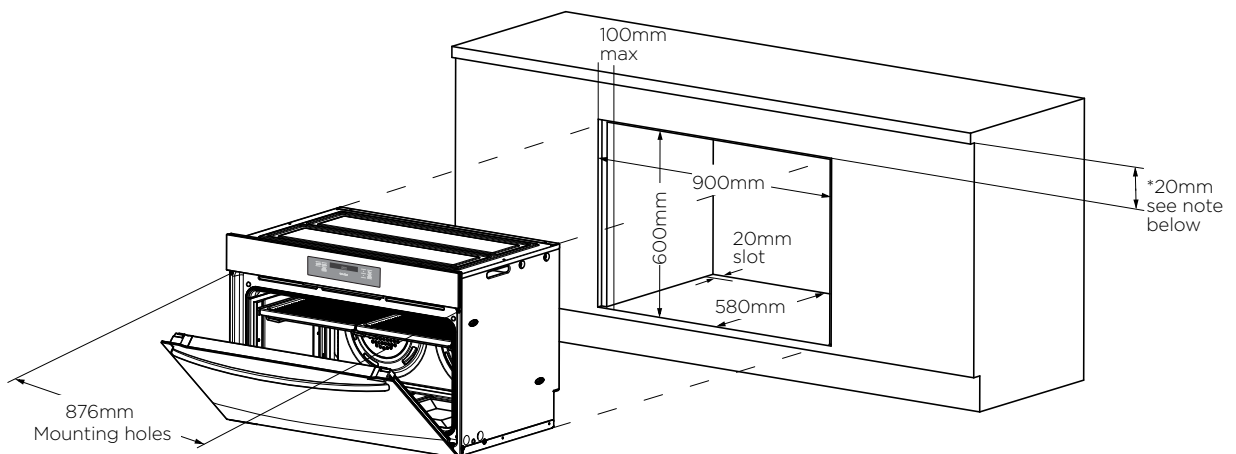
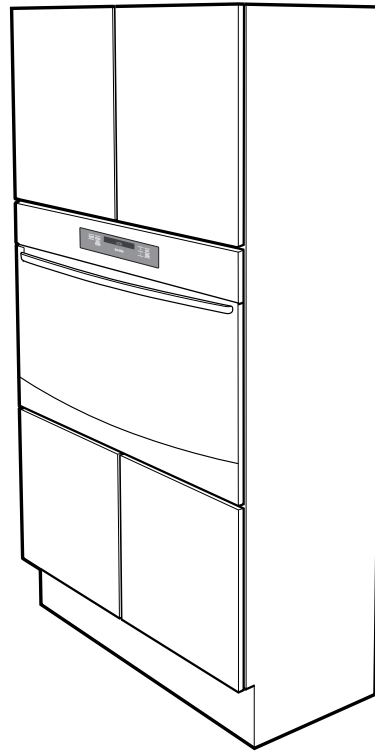

*NOTE: If a powerpoint is fitted it must be accessible with the appliance installed.*

\*Refer to cooktop installation instructions for required clearance between cooktop and oven.

# WIRING REQUIREMENTS

The cooker MUST be installed in compliance with:

- wiring connections in AS/NZS 3000 Wiring Rules.
- local regulations, municipal building codes and other statutory regulations.

### For New Zealand Only:

The cooking range must be connected to the supply by a supply cord fitted with the appropriately rated plug that is compatible with the socket-outlet fitted to the final sub-circuit in the fixed wiring that is intended to supply this cooking range.

### Supply cord size required:

- WFE914SB/WVE914SB/WVE916SB - 1.5mm<sup>2</sup>
- WFEP915SB/WVEP916SB - 4.0mm<sup>2</sup>
- WFE946SB - 6.0mm<sup>2</sup>

The Data plate gives information about rating and is located behind the bottom of the oven door.

- A functional switch MUST be provided near the appliance in an accessible position (AS/NZS 3000 - Clause 4.7.1).
- Wiring MUST be protected against mechanical failure (AS/NZS 3000 - Clause 3.9).
- Disconnection in the fixed wiring must occur in accordance with the AS/NZS3000 wiring rules.
- The cooker MUST be properly earthed.
- This range must be connected with cable of 75°C rating minimum.
- This product has passed the insulation resistance test after manufacture. If the resistance reading is low at installation, it is probably caused by moisture from the atmosphere being absorbed by the elements after the range has been produced. (pass at 0.01 MΩ AS/NZS 3000 Wiring Rules Clause 8.3.6.2).

*Note: When connections are made to a multi-phase 230/240V supply, the bridge piece MUST be removed from between the active connections.*

### Rated power input

MODEL	TOTAL KW	A1 KW	A2 KW
WFE946	12.8	3.6	9.5

### IMPORTANT

Before you cook in your new oven it is important that the protective oils used in the manufacture of the product be removed.

- Make sure that the room is well ventilated (to allow smoke to escape).
- Run the grill on high for 30 minutes without grill dish.
- Then run the oven on 180°C for 1 hour.

### Connecting to services and commissioning

This appliance must be installed by an authorised person, according to all codes and regulations of:

- Electrical supply authorities.
- Building regulations.
- Local government and council authorities.
- AS/NZS5601.1(particular attention to 6.10.1 and figure 6.3, and clause 6.10.1.11).
- AS/NZS 3000 (particular attention to clause 4.3.11 and clause 3.9).

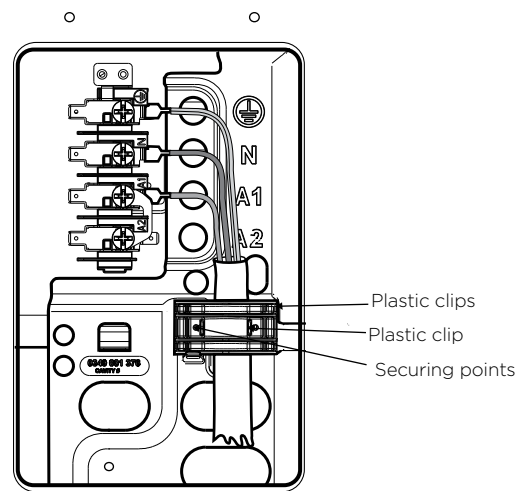

### Hard wiring detail

1. Remove terminal cover plate from rear panel of appliance.
2. Fit wires through hole in cover plate and make connections to terminals.
3. Engage wires into plastic clip. Secure plastic clip with two long silver screws (supplied in separate bag).
4. Replace cover plate onto rear panel.

### Electrical connection location - built-in models

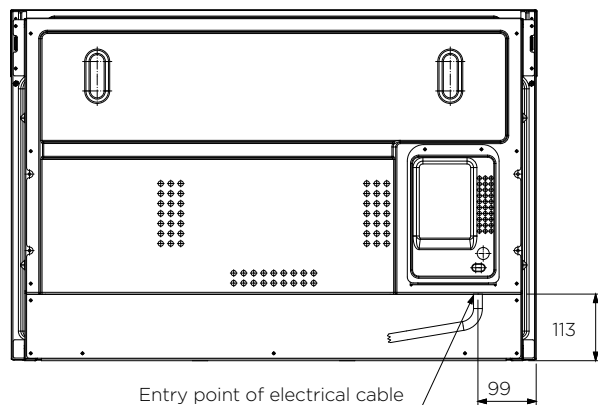

# INSTALLING THE FREESTANDING COOKER

## Models WFE914SB, WFEP915SB AND WFE946SB

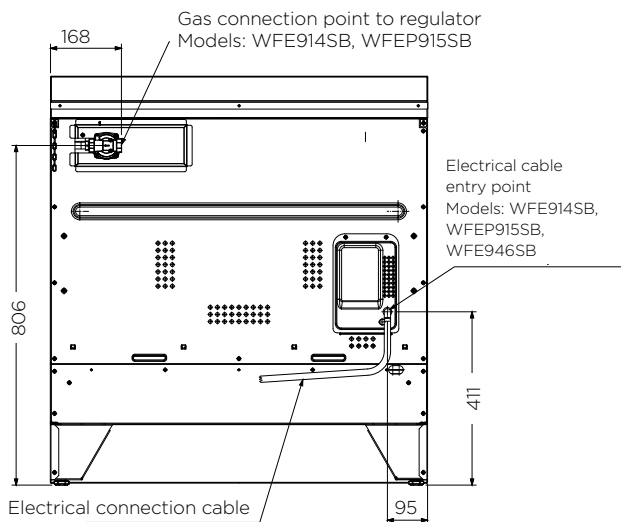

## Gas connection

Read these points before connecting to the gas supply:

- The appliance is preset for natural gas use, if LPG is to be used see Conversion to LPG section.
- Gas installation must be made in accordance with AS/NZS5601.1, the local gas fitting regulations, municipal codes and other statutory regulations.
- The gas connection point is a ½" BSP external thread located at the rear of the appliance as shown.
- The regulator is to be fitted to the manifold inlet at the rear of the appliance and the connection is sealed using a tape or jointing compound suitable for gas connections. The consumer piping is then connected to the inlet of the regulator, either
  1. directly, or
  2. using a hose assembly and in accordance with Clause 6.10.1.9 of AS 560101 (High level connection) together with the supplied elbow. The elbow is fitted to the inlet of the regulator and oriented to allow the hose to hang downward. The connection thread between the regulator and elbow is sealed using a tape or jointing compound suitable for gas connections.

## Gas pressures

The following table shows the supply and operating pressures for various gases.

GAS TYPE	NATURAL GAS	UNIVERSAL LPG
Supply pressure at inlet to appliance regulator (if fitted)	1.13 (kPa) Minimum	2.75* (kPa)
Operating pressure at appliance test point	1.00 (kPa)	2.6 (kPa)

\*If the regulator is placed upstream of the cooker inlet, as is normal for cookers operating on LPG, then the supply pressure and operating pressure are the same.

The following table shows the injector sizes for each burner.

INJECTOR ORIFICE	NATURAL GAS	UNIVERSAL LPG
Low heat burner	1.00mm	0.55mm
Medium heat burner	1.35mm	0.70mm
High heat burner	1.60mm	0.90mm
Intense heat wok burner	1.75mm	1.00mm

## Checking piping size

To work out a suitable pipe size for connection use the information in this table.

GAS TYPE	NATURAL GAS	UNIVERSAL LPG
WFE914 & WFEP915	49.6 MJ/h	40.9 MJ/h

For information and requirements about construction and capacity of consumer piping refer to AS5601 series of standards.

## LPG CONVERSION MODELS WFE914SB & WFEP915SB

This appliance is supplied set up for Natural Gas usage. A conversion kit is included with the product for Universal LPG usage. The conversion kit contains 6 injectors and 1 LPG sticker.

Please follow the procedure below if a conversion to suit UNIVERSAL LPG is required:

1. Remove the hotplate trivets, burner caps and burner crowns to access the hotplate injectors. Replace the factory fitted injectors with the appropriate injectors, as supplied. Refer to injector orifice table for injector sizes. The injector size is stamped on the side of the injector.
2. Unscrew the top hat nut from the regulator. The top hat nut and control pressure spring assembly will disengage as an assembly.
3. Unscrew the threaded pin from top hat.
4. Upturn threaded pin, so spring is free and screw pin back into the top hat until firm.
5. Refit the top hat nut assembly to the regulator ensuring that it is fully screwed down. The regulator is now set for connection to LPG.
6. Turn on the gas supply and at each new connection check for leaks using soapy water. Each hotplate valve should be turned on, one at a time, and the injector hole blanked off for several seconds.
7. The operation of the regulator can be confirmed by connecting a manometer to the pressure test point located on the side of the regulator body adjacent to the outlet.

With the appliance operating check the outlet pressure:

- when all burners of the appliance are operating at maximum,
- when the smallest burner of the appliance is operating at minimum.

Under these conditions the outlet pressure should not vary from the nominal outlet pressure of 2.60kPa by more than  $\pm 0.52\text{kPa}$ .

8. If the regulator appears to not be performing satisfactorily then check the following points:
  - If the outlet pressure is consistently too low then the inlet pressure may be too low and adjustment of an upstream regulator may be needed, or an upstream regulator or valve with insufficient flow capacity may be present in the gas supply line. If this is suspected then it may be necessary to repeat the checks whilst measuring both the inlet and outlet pressure to determine if the inlet pressure is in the range 2.75 – 7.00kPa.
  - Check that the insert has been fitted correctly.
  - Check that the turret screw is fully screwed down.
  - Check that the regulator has been fitted to the gas supply line in the correct orientation, the arrow on the base of the body indicates the direction of gas flow.

Once these checks have been completed, if the regulator still fails to perform in a satisfactory manner it should be replaced.

9. One by one, turn the knobs to minimum and screw in the bypass screw (accessible when the knob is

removed) until a small stable flame results. Turn the knob to maximum and then back to minimum to ensure that the correct minimum flame is maintained.

10. Attach the LPG sticker to the cooker, near the gas supply inlet. Cover the Natural Gas label that is factory fitted.

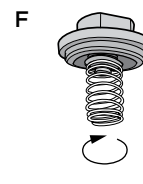
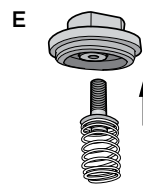
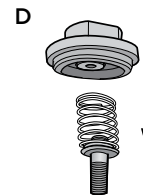
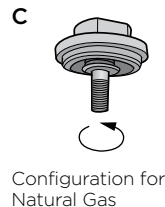
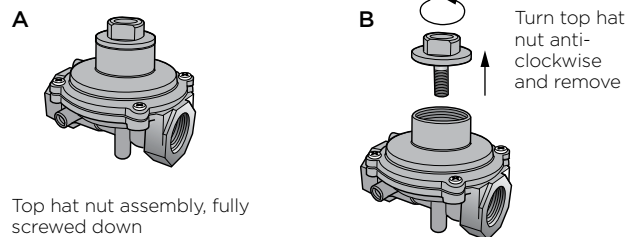

Configuration for LPG

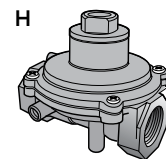
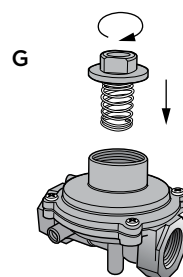

Flame size adjusted to maximum

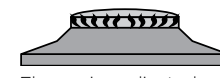

Flame size adjusted to minimum

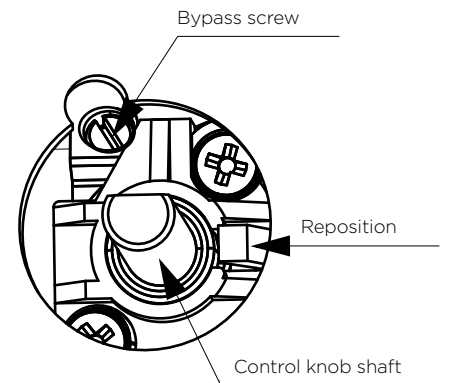

**NOTE:** You **MUST** test the cooker after installation, before you hand it over to the customer. You **MUST** have a manometer and a connecting tube.

# TESTING THE OPERATION OF THE GAS COOKER

## Checking gas supply

1. Check the manometer zero point is correct.
2. Connect the manometer to the cooker pressure test point. This is located on the regulator or LPG inlet fitting.
3. Turn on the gas supply and the electricity and try to ignite the gas.

*NOTE: It will take additional time to light the gas for the first time as air needs to be purged from the pipes.*

4. Check the operating pressure for the particular gas type.

## Checking the function of the regulator

With the appliance operating check the outlet pressure:

- when all burners of the appliance are operating at maximum,
- when the smallest burner of the appliance is operating at minimum.

Under these conditions the outlet pressure should not vary from the nominal outlet pressure by more than  $\pm 20\%$  of the nominal outlet pressure (ie  $\pm 0.20\text{kPa}$  for Natural Gas).

If the regulator appears to not be performing satisfactorily then check the following points.

1. If the outlet pressure is consistently too low then the inlet pressure may be too low and adjustment of an upstream regulator may be needed, or an upstream regulator or valve with insufficient flow capacity may be present in the gas supply line. If this is suspected then it may be necessary to repeat the checks whilst measuring both the inlet and outlet pressure to determine if the inlet pressure is in the range 1.13 – 5kPa.
2. Check that the regulator has been fitted to the gas supply line in the correct orientation, the arrow on the base of the body indicates the direction of gas flow.

Once these checks have been completed, if the regulator still fails to perform in a satisfactory manner it should be replaced.

## Testing the cooker features

- Observe the flame appearance on each burner. If it is much smaller or larger than expected, then the injector size needs checking.

*NOTE: When flame is unsatisfactory, then refer to the Electrolux Technical Publications and correct the fault, if possible.*

When maximum flame appearance is correct, then check the turn-down setting on each burner. If the settings appear to be incorrect, proceed as follows:

1. Adjust the bypass screw mounted on the body of each hotplate control cock. This is accessible when the control knob and the control panel are removed.
2. Check the ignition on all burners both separately and in combination.
3. Check the operation of the electrical components, if applicable.
4. If you are satisfied that the cooker is operating correctly, then turn it off and show the customer how to use it. Make sure you ask the customer to operate the clock and controls.

*NOTE: If the cooker cannot be adjusted to perform correctly, then inform the customer of the problem and put a warning notice on the cooker. If the problem is dangerous, then disconnect the cooker. If there is a fault, then the customer should be advised to contact the manufacturer's local service organisation or the retailer.*

## NOTES

---

---

---

---

---

---

---

---

---

---

---

---

---

---

---

---

---

---

---

---

---

---

---

---

---

---

# Electrolux Warranty

FOR SALES IN AUSTRALIA AND NEW ZEALAND  
 APPLIANCE: WESTINGHOUSE BUILT-IN OVENS, COOKTOPS AND  
 FREESTANDING COOKER

**This document sets out the terms and conditions of the product warranties for Westinghouse Appliances. It is an important document. Please keep it with your proof of purchase documents in a safe place for future reference should there be a manufacturing defect in your Appliance. This warranty is in addition to other rights you may have under the Australian Consumer Law.**

**1. In this warranty:**

- (a) 'ACL' or 'Australian Consumer Law' means Schedule 2 to the Competition and Consumer Act 2010;
- (b) 'Appliance' means any Electrolux product purchased by you and accompanied by this document;
- (c) 'ASC' means Electrolux's authorised serviced centres;
- (d) 'Westinghouse' is the brand controlled by Electrolux Home Products Pty Ltd of 163 O'Riordan Street, Mascot NSW 2020, ABN 51 004 762 341 in respect of Appliances purchased in Australia and Electrolux (NZ) Limited (collectively "Electrolux") of 3-5 Niall Burgess Road, Mount Wellington, in respect of Appliances purchased in New Zealand;
- (e) 'Warranty Period' means the period specified in clause 3 of this warranty;
- (f) 'you' means the purchaser of the Appliance not having purchased the Appliance for re-sale, and 'your' has a corresponding meaning.

**2. Application:** This warranty only applies to new Appliances, purchased and used in Australia or New Zealand and is in addition to (and does not exclude, restrict, or modify in any way) other rights and remedies under a law to which the Appliances or services relate, including any non-excludable statutory guarantees in Australia and New Zealand.

**3. Warranty Period:** Subject to these terms and conditions, this warranty continues in Australia for a period of 24 months and in New Zealand for a period of 24 months, following the date of original purchase of the Appliance.

**4. Repair or replace warranty:** During the Warranty Period, Electrolux or its ASC will, at no extra charge if your Appliance is readily accessible for service, without special equipment and subject to these terms and conditions, repair or replace any parts which it considers to be defective. Electrolux may, in its absolute discretion, choose whether the remedy offered for a valid warranty claim is repair or replacement. Electrolux or its ASC may use refurbished parts to repair your Appliance. You agree that any replaced Appliances or parts become the property of Electrolux.

**5. Travel and transportation costs:** Subject to clause 7, Electrolux will bear the reasonable cost of transportation, travel and delivery of the Appliance to and from Electrolux or its ASC. Travel and transportation will be arranged by Electrolux as part of any valid warranty claim.

**6. Proof of purchase** is required before you can make a claim under this warranty.

**7. Exclusions:** You may not make a claim under this warranty unless the defect claimed is due to faulty or defective parts or workmanship. This warranty does not cover:

- (a) light globes, batteries, filters or similar perishable parts;
- (b) parts and Appliances not supplied by Electrolux;
- (c) cosmetic damage which does not affect the operation of the Appliance;

- (d) damage to the Appliance caused by:
  - (i) negligence or accident;
  - (ii) misuse or abuse, including failure to properly maintain or service;
  - (iii) improper, negligent or faulty servicing or repair works done by anyone other than an Electrolux authorised repairer or ASC;
  - (iv) normal wear and tear;
  - (v) power surges, electrical storm damage or incorrect power supply;
  - (vi) incomplete or improper installation;
  - (vii) incorrect, improper or inappropriate operation;
  - (viii) insect or vermin infestation;
  - (ix) failure to comply with any additional instructions supplied with the Appliance;

In addition, Electrolux is not liable under this warranty if:

- (a) the Appliance has been, or Electrolux reasonably believes that the Appliance has been, used for purposes other than those for which the Appliance was intended, including where the Appliance has been used for any non-domestic purpose;
- (b) the Appliance is modified without authority from Electrolux in writing;
- (c) the Appliance's serial number or warranty seal has been removed or defaced

**8. How to claim under this warranty:** To enquire about claiming under this warranty, please follow these steps:

- (a) carefully check the operating instructions, user manual and the terms of this warranty;
- (b) have the model and serial number of the Appliance available;
- (c) have the proof of purchase (e.g. an invoice) available;
- (d) telephone the numbers shown below.

**9. Australia:** For Appliances and services provided by Electrolux in Australia: Electrolux goods come with guarantees that cannot be excluded under the Australian Consumer Law. You are entitled to a replacement or refund for a major failure and for compensation for any other reasonably foreseeable loss or damage. You are also entitled to have the Appliance repaired or replaced if the Appliance fails to be of acceptable quality and the failure does not amount to a major failure. 'Acceptable quality' and 'major failure' have the same meaning as referred to in the ACL.

**10. New Zealand:** For Appliances and services provided by Electrolux in New Zealand, the Appliances come with a guarantee by Electrolux pursuant to the provisions of the Consumer Guarantees Act, the Sale of Goods Act and the Fair Trading Act. Where the Appliance was purchased in New Zealand for commercial purposes the Consumer Guarantee Act does not apply.

**11. Confidentiality:** You accept that if you make a warranty claim, Electrolux and its agents including ASC may exchange information in relation to you to enable Electrolux to meet its obligations under this warranty.

**Important Notice**

Before calling for service, please ensure that the steps listed in clause 8 above have been followed.

<p><b>FOR SERVICE</b>          or to find the address of your nearest authorised service centre in Australia  <b>PLEASE CALL 13 13 49</b>  <small>For the cost of a local call (Australia only)</small></p>	<p><b>AUSTRALIA</b>          ELECTROLUX HOME PRODUCTS          163 O'Riordan Street, Mascot NSW 2020          electrolux.com.au</p>	<p><b>FOR SPARE PARTS</b>          or to find the address of your nearest spare parts centre in Australia  <b>PLEASE CALL 13 13 50</b>  <small>For the cost of a local call (Australia only)</small></p>
<p><b>FOR SERVICE</b>          or to find the address of your nearest authorised service centre in New Zealand  <b>PLEASE CALL 0800 10 66 10</b>  <small>(New Zealand only)</small></p>	<p><b>NEW ZEALAND</b>          ELECTROLUX (NZ) Limited          3-5 Niall Burgess Road, Mount Wellington          electrolux.co.nz</p>	<p><b>FOR SPARE PARTS</b>          or to find the address of your nearest spare parts centre in New Zealand  <b>PLEASE CALL 0800 10 66 20</b>  <small>(New Zealand only)</small></p>

**For more information on all Westinghouse appliances, or for dimension and installation information, call into your retailer, phone or email our customer care team or visit our website:**

#### **AUSTRALIA**

phone: 1300 363 640

fax: 1800 350 067

email: [customercare@electrolux.com.au](mailto:customercare@electrolux.com.au)

web: [westinghouse.com.au](http://westinghouse.com.au)

#### **NEW ZEALAND**

phone: 0800 436 245

fax: 0800 225 088

email: [customercare@electrolux.co.nz](mailto:customercare@electrolux.co.nz)

web: [westinghouse.co.nz](http://westinghouse.co.nz)

#### **TOP SERVICE**

Top Service encompasses the after sales service provided by The Electrolux Group to consumers including delivery, home service and spare parts.

 and WESTINGHOUSE are trademarks of Westinghouse Electric Corporation. Used under license by Electrolux Home Products Pty Ltd. All Rights Reserved.

Part Number: A14446401 REV B  
© 2019 Electrolux Home Products Pty Ltd  
ABN 51 004 762 341  
ECN: 109613  
WMAN\_W100\_90cm\_Mar19