

**REGISTER YOUR  
APPLIANCE TODAY**

to get product tips, safety  
notifications and more.

[westinghouse.com.au/register](http://westinghouse.com.au/register)

## **REFRIGERATION**

Side by Side

## CONGRATULATIONS

Dear customer,

Congratulations and thank you for choosing our refrigerator. We are sure you will find your new refrigerator a pleasure to use. Before you use the refrigerator we recommend that you read through the relevant sections of this manual, which provides a description of your refrigerator and its functions.

To avoid the risks that are always present when you use an electric appliance, it is important that the refrigerator is installed correctly and that you read the safety instructions carefully to avoid misuse and hazards.

We recommend that you keep this instruction booklet for future reference and pass it on to any future owners.

After unpacking the refrigerator, please check it is not damaged. If in doubt, do not use the refrigerator but contact your local customer care centre.

### Conditions of Use

This refrigerator is designed and intended to be used in normal domestic applications only:

- By clients in hotels, motels and other residential type environments
- Bed and breakfast type environments

Record model and serial number here:

Model number:.....

Serial number:.....

**Please read the user manual carefully and store in a handy place for later reference. The symbols you will see in this booklet have these meanings:**



### WARNING

This symbol indicates information concerning your personal safety



### CAUTION

This symbol indicates information on how to avoid damaging the appliance



### TIPS AND INFORMATION

This symbol indicates tips and information about use of the appliance



### ENVIRONMENT

This symbol indicates tips and information about economical and ecological use of the appliance

## CONTENTS

Important safety instructions.....	3
Refrigerator features	
Non ice and water refrigerator features.....	4
Ice and water refrigerator features.....	5
Installing your new refrigerator	
Unpacking your refrigerator.....	6
Locating your refrigerator.....	6
Installing your refrigerator.....	6
Fitting the handles.....	7
Ice and water installation	
Water filter.....	7
Water supply and plumbing.....	8
Replacing the water filter.....	10
Using your refrigerator.....	11
Removing features.....	12
User interface	
Non ice and water model.....	13
Ice and water model.....	14
General information	
Cleaning the refrigerator.....	16
Food storage guide.....	17
Troubleshooting	
Temperature.....	18
Noise.....	18
Crisper operation.....	18
Refrigerator operation.....	19
Door operation.....	20
Automatic ice maker.....	20
Ice dispenser.....	21
Notes.....	22
Warranty information.....	23



### TIPS AND INFORMATION

Important - CHECK FOR ANY DAMAGE OR MARKS

If you find the appliance is damaged or marked, you must report it within 7 days if you wish to claim for damage/marks under the manufacturer's warranty. This does not affect your statutory rights.



### ENVIRONMENT

Information on disposal for users

- Most of the packing materials are recyclable. Please dispose of those materials through your local recycling depot or by placing them in appropriate collection containers.
- If you wish to discard this product, please contact your local authorities and ask for the correct method of disposal.

### IMPORTANT INFORMATION THAT MAY IMPACT YOUR MANUFACTURER'S WARRANTY

Adherence to the directions for use in this manual is extremely important for health and safety. Failure to strictly adhere to the requirements in this manual may result in personal injury, property damage and affect your ability to make a claim under the Westinghouse manufacturer's warranty provided with your product. Products must be used, installed and operated in accordance with this manual. You may not be able to claim on the Westinghouse manufacturer's warranty in the event that your product fault is due to failure to adhere this manual.

## IMPORTANT SAFETY INSTRUCTIONS

*Note: You must read these warnings carefully before installing or using the refrigerator. If you need assistance, contact your customer care centre. The manufacturer will not accept liability, should these instructions or any other safety instructions incorporated in this book be ignored.*



### WARNING

- This appliance is not intended for use by persons (including children) with reduced physical, sensory or mental capabilities, or lack of experience and knowledge, unless they have been given supervision or instruction concerning use of the appliance by a person responsible for their safety. Children should be supervised to ensure that they do not play with the appliance.
- It is essential the power point is properly earthed to ground. Consult a qualified electrician if you are unsure.
- Do not use electrical appliances inside the food storage compartments of the appliance, unless they are of the type recommended by the manufacturer.
- Unplug the refrigerator before cleaning or moving it to avoid electric shock.
- Never unplug the refrigerator by pulling the electrical cord as this may damage it. Grip the plug firmly and pull straight out.
- If the power cord is damaged, it must be replaced by the manufacturer, its service agent or similarly qualified persons in order to avoid a hazard.
- Don't use a steam cleaner. If live components come into contact with condensing steam, they may short-circuit or cause an electric shock.
- Do not store explosive substances such as aerosol cans with a flammable propellant in this appliance. If pressurised aerosol containers bear the word 'flammable' and/or a small flame symbol, do not store them inside any refrigerator or freezer. If you do so you may cause an explosion.
- Do not damage the refrigerant circuit.

- Wait at least 4 hours before connecting the appliance to the power supply. This is to allow the oil to flow back in the compressor.
- This appliance contains insulation formed with flammable blowing gases. Avoid safety hazards by carefully disposing of this appliance.
- If you wish to discard this refrigerator, please contact your local authorities and ask for the correct method of disposal.
- When you dispose of your old refrigerators and freezers, remove any doors. Children can suffocate if they get trapped inside.
- The plug must be accessible when the appliance is in position.
- Never try to repair the refrigerator yourself, only use a qualified or authorized service person for repairs.



### WARNING

#### R600a refrigerant warning

This appliance contains flammable R600a refrigerant. Avoid safety hazards by carefully installing, handling, servicing and disposing of this appliance.

- Ensure that the tubing of the refrigerant circuit is not damaged during transportation and installation.
- Leaking refrigerant may cause eye injuries or ignite.
- The room for installing appliance must be at least 1m<sup>3</sup> per 8g of refrigerant. The amount of refrigerant in the appliance can be found on the rating plate inside the appliance.
- If you are unsure of the refrigerant check the rating plate inside the refrigerator compartment.
- It is hazardous for anyone other than an Authorised Service Person to service this appliance. In Queensland Australia the Authorisation Service Person MUST hold a Gas Work Authorisation for hydrocarbon refrigerants to carry out servicing or repairs which involve the removal of covers.
- Keep ventilation openings in the appliance enclosure or in the built-in structure, clear of obstruction.
- Do not use mechanical devices or other means to accelerate the defrosting process, other than those recommended by the manufacturer.

## NON ICE AND WATER FEATURES

- 1 LED lighting
- 2 SpillSafe™ glass shelves - The glass shelves improve visibility and isolate leaks - preventing spills from dripping down to the shelves below.
- 3 Twist and Serve Ice maker.
- 4 Humidity control - Change the humidity by sliding the humidity control. Less humid conditions are recommended for fruit, while more humid conditions are recommended for vegetables.
- 5 Freezer door bin.
- 6 Freezer baskets.
- 7 FamilySafe lockable compartment - This compartment can be used to store dairy and is also lockable for storing items like cosmetics and medicines. To operate the lock, squeeze and turn the knob located on the front of the bin as indicated.
- 8 FlexStor bins - Slide FlexStor bins to meet different storage needs. To remove, lift and tilt. To replace, tilt the top and push down until locked in place.
- 9 FlexFresh crisper - Use the crisper to store vegetables, fruit or small goods. Change the humidity by sliding the humidity control.

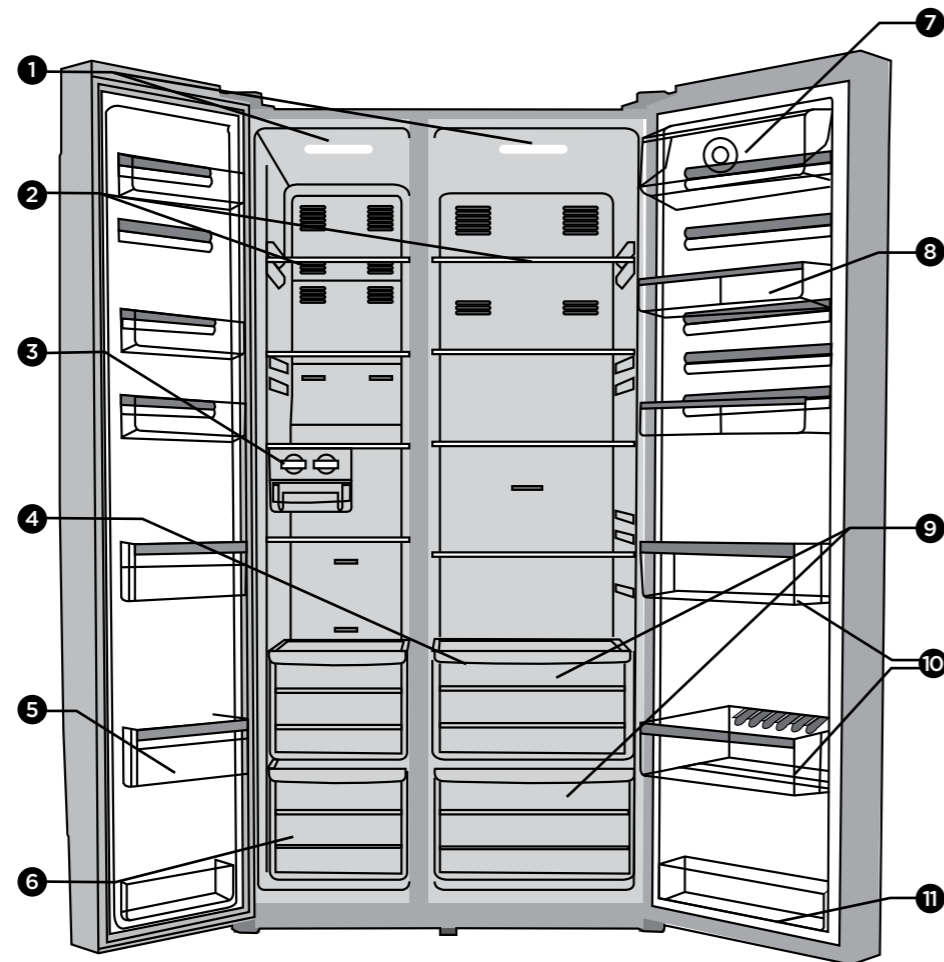

- 10 Bottle storage bin with fingers - Use the bottle bin for tall bottle storage. The bottle bin can be removed by lifting it up over the support lugs. To replace, push down over the support lugs to lock in place.
- 11 Can bin - Use the can for the handy storage of cans or small jars.

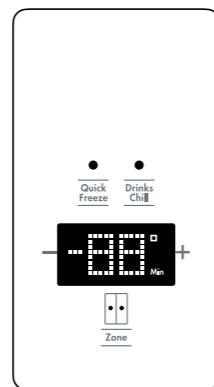

### Control panel

From this panel you can control the temperature of the refrigerator and freezer compartments as well as setting the quick freeze and drinks chill functions.

For further information on how to use this feature refer to the section "About the User Interface".

Features may vary depending on model. Not all models will have features listed.

## ICE AND WATER FEATURES

- 1 Water filter.
- 2 Ice maker.
- 3 Ice Storage Bin - Refer to the section "Using your Refrigerator" for details on using this feature.
- 4 LED lighting
- 5 SpillSafe™ glass shelves - The glass shelves improve visibility and isolate leaks - preventing spills from dripping down to the shelves below.
- 6 Humidity control - Change the humidity by sliding the humidity control. Less humid conditions are recommended.
- 7 Freezer door bin.
- 8 Freezer baskets.
- 9 FamilySafe lockable compartment - This compartment can be used to store dairy and is also lockable for storing items like cosmetics and medicines. To operate the lock, squeeze and turn the knob located on the front of the bin as indicated.
- 10 FlexStor bins - Slide FlexStor bins to meet different storage needs. To remove, lift and tilt. To replace, tilt the top and push down until locked in place.
- 11 FlexFresh crisper - Use the crisper to store vegetables, fruit or small goods. Change the humidity by sliding the humidity control.

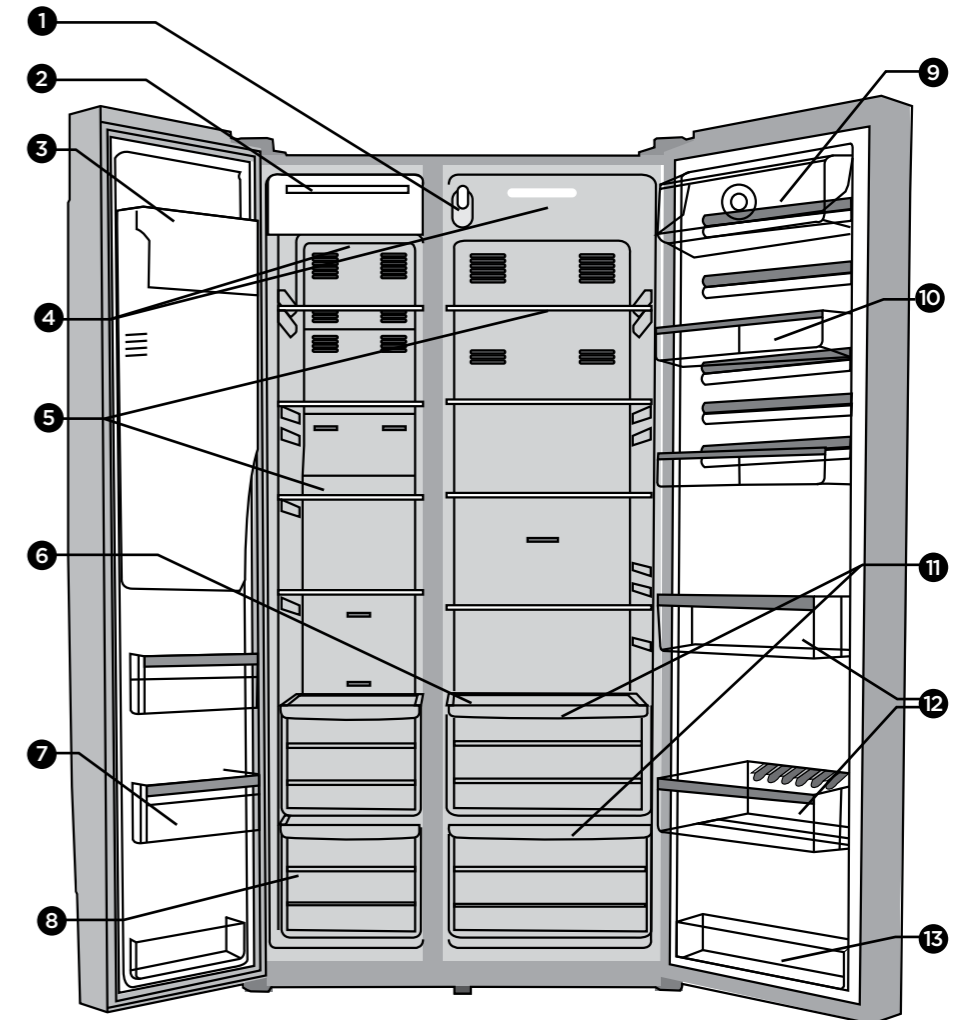

- 12 Bottle storage bin with fingers - Use the bottle bin for tall bottle storage. The bottle bin can be removed by lifting it up over the support lugs. To replace, push down over the support lugs to lock in place.
- 13 Can bin - Use the can for the handy storage of cans or small jars.

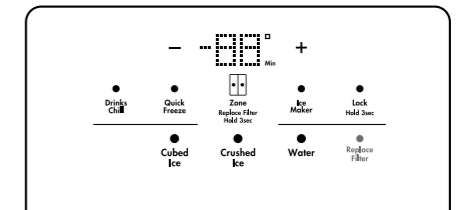

### Control panel

From this panel you can control the temperature of the refrigerator and freezer compartments as well as setting the quick freeze and all the icemaker functions.

For further information on how to use this feature refer to the section "About the User Interface".

Features may vary depending on model. Not all models will have features listed.



## INSTALLING YOUR NEW REFRIGERATOR

### Unpacking

### ENVIRONMENT

Most of the packing materials are recyclable. Please dispose of those materials through your local recycling depot or by placing them in appropriate collection containers.

Important - check for any damages or marks. If you find the refrigerator is damaged or marked, you must report it within 7 days should you wish to claim for damage/marks under the manufacturers warranty. This does not affect your statutory rights.

Clean your refrigerator thoroughly following the instructions in the "Cleaning" section and wipe off any dust that has accumulated during shipping.

### Locating the refrigerator

### CAUTION

Automatic aerosol systems (such as insect control) should not be located adjacent to the product as the spray may cause long term damage to the external plastics of the appliance.

Do not put the refrigerator in a location that is too cold or is unprotected, for example in a garage or on a veranda.

For optimal performance the ambient temperature should be between 10°C and 43°C.

Put the refrigerator in a dry place avoiding areas of high moisture or humidity.

Ensure the refrigerator is located on an even surface.

### Adequate ventilation around your refrigerator

The diagram below shows the recommended airspace to allow for ventilation of your refrigerator.

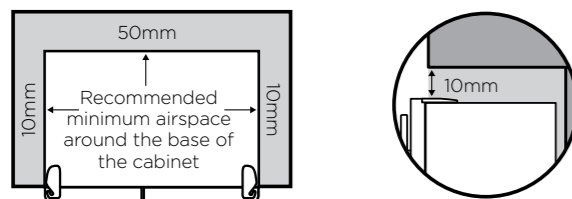

Note: 10mm clearance at the top of the cabinet is once the cabinet is tilted back and in its final location.

Allow a 250 - 350mm minimum clearance on the hinge side of the doors, if you place the refrigerator next to the wall. This will make cleaning easier.

Make sure that cupboards or fixtures do not stick out further than the refrigerator cabinet.

NOTE: Doors are designed to sit proud of cabinetry (not flush). The clearances shown above are the recommended minimum clearances.

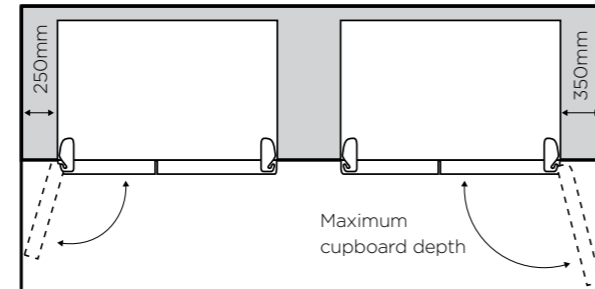

### Installing your refrigerator

1. Roll the refrigerator into place.

The rollers are designed for forward or backward movement only. They are not castors. Moving the refrigerator sideways may damage your floor and the rollers. Before moving your refrigerator ensure the adjusting nuts are fully wound up off the floor.

2. Using spanner supplied, wind the large height adjusting nuts under door hinges down until the refrigerator is tilted back by 10 - 15mm (see diagram) and the cabinet is stable. If you have difficulty winding the nut or height adjusting foot down, have someone tilt the refrigerator back so you have better access.

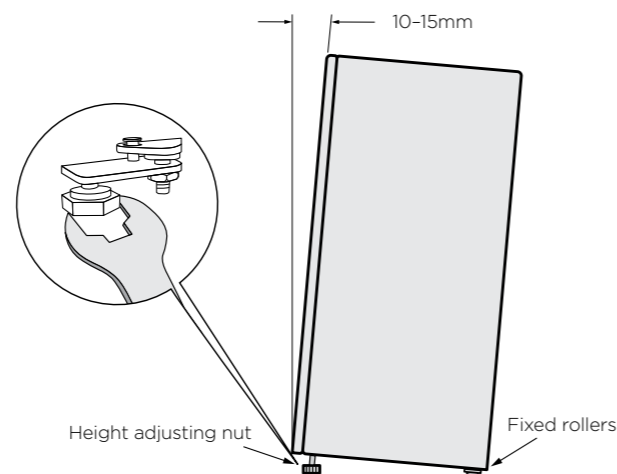

3. Check the alignment of the refrigerator to the surrounding cupboards to see if it is level. You can adjust the level as detailed in step 2.
4. If you find your refrigerator rocks from corner to corner, it means your floor is uneven. Find a piece of plastic or hardboard etc. and pack it firmly under the foot.
5. You may now need to fine-tune the installation by repeating steps 2, 3 and 4.

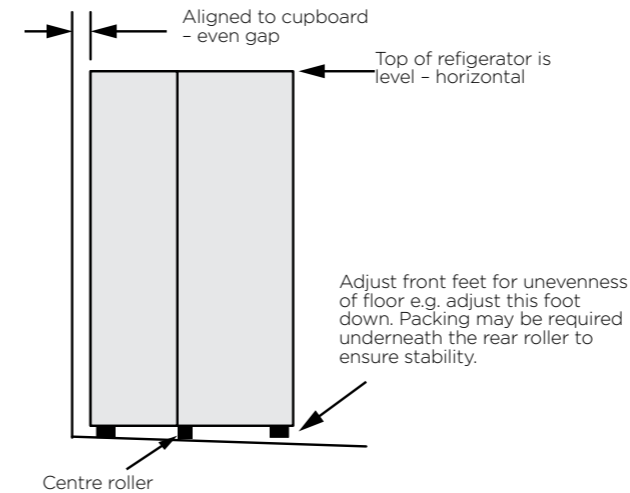

6. Plug your refrigerator straight into its own power point and never use a double adapter.
7. Before you put any food in your refrigerator, it's recommended you leave it on for 2 or 3 hours to check it is running properly.

### Fitting the handles

The handles are supplied prepackaged inside your refrigerator and will require fitting. Refer to the instructions provided in the pack.

### Adjusting door alignment

The doors can be aligned by adjusting the right hand door up or down by turning the adjustable bolt under the hinge using the spanner provided.

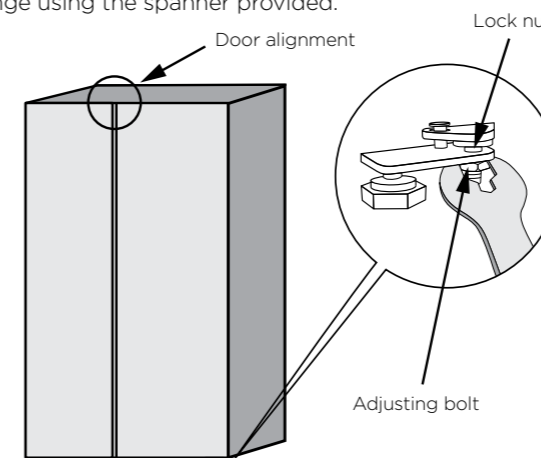

1. Loosen lock nut
2. Turn adjusting bolt until doors are aligned
3. Tighten lock nut

NOTE: When the height of the rollers and adjusting bolts are correctly adjusted the refrigerator will stand firmly on the floor and the doors will be in line with one another.

### Fitting the handles

The handles are supplied prepackaged inside your refrigerator and will require fitting. Refer to the instructions provided in the pack.

## ICE AND WATER INSTALLATION

### WARNING

Connect to potable water supply only.

The new hose-sets supplied with the appliance must be used and old hose-sets should not be reused.

Never connect the appliance to a hot water supply.

Do not use with water that is microbiologically unsafe or with water of unknown quality without adequate disinfection.

### Water Filter

The service life of the filter may be reduced in water supplies that contain an excess of particles or other impurities. Reduced flow rate is an indication that a new filter is required. Failure to replace the filter when required can affect the function of the ice maker. Service calls caused by a failure to replace the filter are not covered by warranty. Replacement water filters are available from Electrolux Home Products Spare Parts Centres and can be posted to you for your convenience (refer to spare parts contact numbers on the warranty page).

### Contents of installation kit

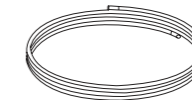

4 metres of water tubing

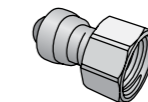

1 x 1/2" tap fitting

### Water supply and plumbing

A drinkable water supply to suit a 1/2" tap fitting is required adjacent to the refrigerator. It is recommended that a licensed plumber install a new water supply outlet nearer to the appliance should the tubing supplied not be long enough. It is not recommended that the tubing be extended as this could adversely affect the flow of water to the ice maker or water dispenser. The water dispenser and automatic ice maker require a drinkable water supply with a pressure range of between 206kPa and 689kPa (30PSI and 100PSI). If the water supply is above 100psi a pressure limiting valve should be installed.

It is recommended that a noise reduction valve also be fitted in the water supply line. This will reduce water hammer and its effects from quick action household taps and fast acting valves on appliances.

The refrigerator water valve is pre-fitted with a push-fit connector for inserting the water tube. When the tap connection is other than 1/2", adapters can be purchased from plumbing supply stores or good hardware stores.

**Please read before beginning installation.**

The water connection to your ice and water product can be self installed. However, it is recommended that you seek advice from a licensed plumber before commencing the installation.

**i IMPORTANT**

Check for water leaks at all water connection points in the first 2 to 3 hours after installation, and correct it in case of any water leak. Recheck after 24 hours; if leak still occurs, it is recommended to contact a licensed plumber for advice.

Water is to be connected as per diagram below.

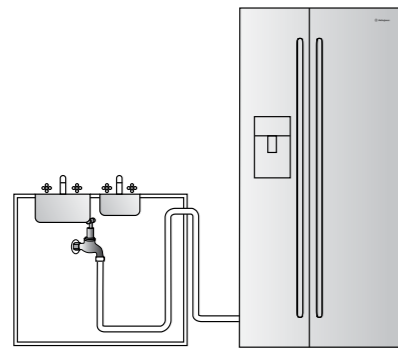

1. Ensure that the refrigerator is disconnected from power supply.

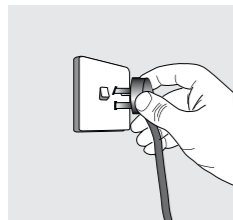

2. Connect tap fitting to water supply tap. Tap must be close to the refrigerator.

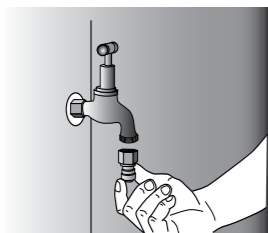

3. Push the tube into tap fitting past insertion mark.
4. Connect other end of remaining tube length to inlet on bottom right hand side of refrigerator.

5. Turn on water and check all joints and tubes for leaks.

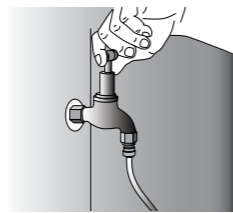

6. Reconnect the power.
7. Move the refrigerator back into place being careful not to kink or split the tubing.
8. Switch ON Water Dispenser.

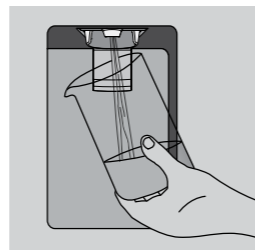

Using a large container, run the water dispenser to clear air from lines. This may take a few minutes. Purge and dispense a minimum of 2 litres of water. Initial water may be black in colour. This is residual carbon dust from the filter and is non-toxic. If the water is slow to shut off or the dispenser is dripping, air may still be in the lines. Either purge more water through the system to remove this air or allow some time for the air to be removed over subsequent dispensing.

**i IMPORTANT**

As the water cut off is not instant, leave glass under dispenser briefly until water has stopped flowing to avoid spills.

Clean and empty the dispenser drip tray regularly to avoid overflow.

If you have not used the dispenser for some time, discard the first seven or eight cups of water (contaminants could have settled in the water pipes).

9. Switch ON Ice Maker. Once the refrigerator has been running for at least 24 hours remove the ice bin and dispose of the first few batches of ice to ensure that impurities have been flushed from the system.

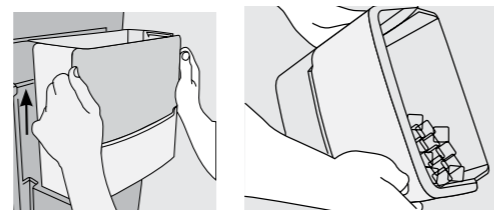

**TIPS AND USEFUL INFORMATION**

Always fit filter as per manufacturer's instructions.

If you need to replace water tube, only use approved water quality piping that meets the pressure requirements.

DO NOT allow the water tubing to become kinked or trapped under the refrigerator when moving the refrigerator back into position.

Make sure your refrigerator is level to avoid uneven or oversize cubes. Uneven ice cubes may lead to the dispenser chute becoming blocked.

After installation, run the water dispenser for a few minutes to ensure that all air bubbles have been purged from the tubing. Dripping may occur if air bubbles remain in the tube.

Replace filter at suggested intervals to avoid water/ice reduction and irregularities in taste.

Remove and clean ice bin once a month, discarding unused ice cubes. This will ensure fresh, clean ice and smooth operation of your ice maker.

Clean and empty the dispenser drip tray regularly to avoid overflow.

As the water/ice cut off is not instant, leave glass under dispenser briefly until water or ice has stopped flowing to avoid spills.

Always place ice in glass before filling with water to avoid splashing.

When dispensing ice hold the container close to the chute to avoid spray or spills.

If you are using your refrigerator for the first time, or if you have not used the dispenser for some time:

- Discard the first seven or eight cups of water
- Discard any ice that the ice maker produces in the first 24 hours (contaminants could have settled in the water pipes).

**! WARNING**

Connect to potable water supply only. Do not put fingers into the ice crusher. Surfaces there may be sharp.

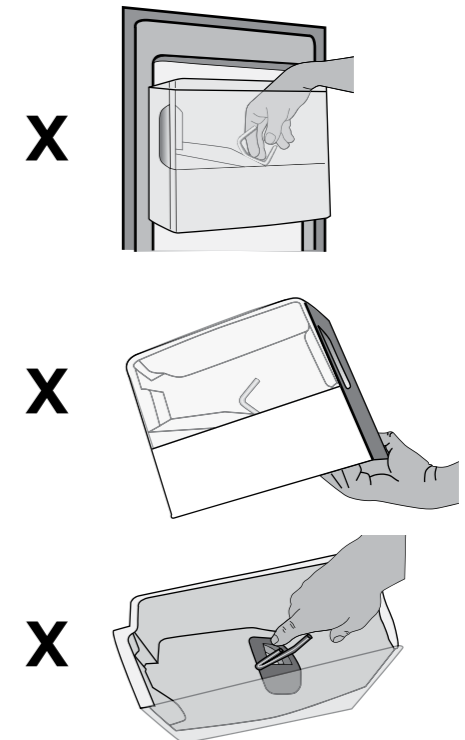

## CHANGING THE WATER FILTER

### **i** IMPORTANT

- Always fit the filter as per manufacturer's instructions.
- If you need to replace the water tube, only use approved water quality piping that meets the pressure requirements.
- Make sure your refrigerator is level to avoid uneven ice cubes.
- Replace filter at suggested intervals to avoid water/ice reduction and irregularities in taste.
- Remove and clean ice bin once a month, discarding unused ice cubes. This will ensure fresh, clean ice and smooth operation of your ice maker.
- Clean and empty the dispenser drip tray regularly to avoid overflow.

### **!** WARNING

If you have not used the dispenser for some time, discard the first seven or eight cups of water and any ice that the ice maker produces in the first 24 hours (contaminants could have settled in the water pipes).

#### Water filter

The water filter is located at the top left side of the fresh food compartment.

#### Replacing the water filter

You should change the water filter every six months to ensure the highest possible water quality.

If your refrigerator has not been used for a period of time (during a house move for example), change the filter before reinstalling the refrigerator.

It is not necessary to turn the water supply off to change the filter. Be ready to wipe up any small amounts of water released during the filter replacement.

1. Ensure that the ice maker is turned off.

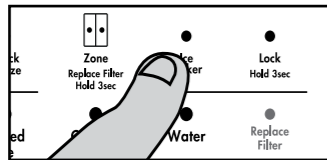

2. Remove the filter by turning anti-clockwise 180°
3. Slide the old water filter cartridge straight out of the housing and discard it.

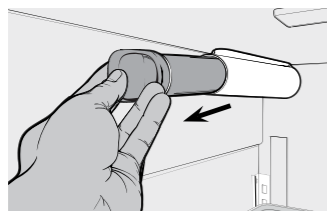

4. Unwrap the new filter cartridge and using the alignment guide, slide it gently into filter housing until it stops against the filter connection at the back of the housing.

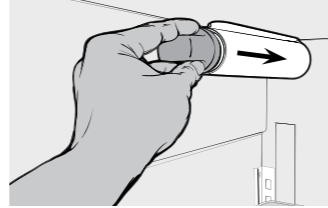

5. Engage the filter by firmly rotating clockwise until the filter snaps into position (once engaged the filter cannot be rotated further).

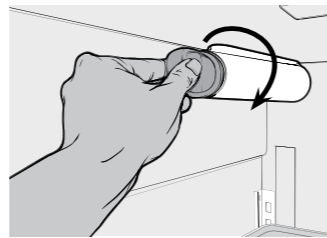

6. Press a drinking glass against the water dispenser while checking for any leaks at the filter housing. Any spurts and sputters that occur as the system purges air out of the dispenser system are normal.
7. After filling one glass of water, continue flushing the system for about four minutes.
8. Turn on the ice maker.

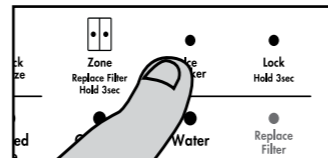

9. When the filter has been replaced press and hold the 'Ice and Water' button for three seconds to reset the filter replace timer.

## USING YOUR REFRIGERATOR

Refrigerators work by transferring heat from the food inside to the outside air. This operation makes the back and sides of the refrigerator feel warm or even hot particularly at start-up and on warm days – this is normal.

Avoid placing food against the air vents in the refrigerator as it affects efficient circulation. If the door is opened frequently, a light frosting will occasionally occur on the freezer's interior. This is normal and will clear after a few days. If the freezer door is accidentally kept open, a heavy frost will coat the inside walls and should be removed.

Your new refrigerator uses a high-speed compressor, along with other energy-efficient components, which may make unusual sounds and be more noticeable at night and quieter times. These sounds simply indicate your refrigerator is working how it should. They include:

- Compressor running noises;
- Air movement noise from the small fan motor;
- A gurgling sound, similar to water boiling;
- A popping noise, heard during automatic defrosting; and
- A clicking noise, prior to compressor start-up.

Further details can be found in the Troubleshooting Guide.

#### Temperature Sensors

Avoid loading food against your freezer temperature sensor.

Doing so may adversely affect freezer temperatures. If warm food is inadvertently loaded against the sensor, it may also set off the freezer temperature alarm for up to 50 minutes after the food is loaded against the sensor.

#### Twist ice and Serve

To use, remove the tray, fill with water and place back in the freezer.

Once ice has formed (approximately 3 hours) simply twist the knob at the front clockwise until the ice drops into the bin below.

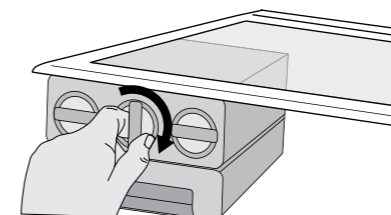

#### Ice and water dispenser features

The ice and water dispenser conveniently dispenses cool, filtered water and ice cubes or crushed ice.

To operate the ice dispenser, select an ice option using the electronic display and press a glass against the dispensing paddle.

To stop dispensing ice, pull the glass away from the dispensing paddle. Remove the glass from the dispenser paddle when it is approximately half full.

Ice already in the chute may cause the glass to overflow or back up into the chute and cause a blockage (refer to troubleshooting guide on how to unblock the ice chute).

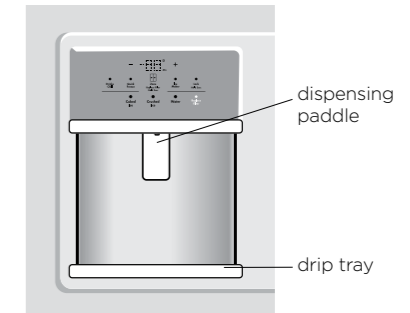

To operate the water dispenser, select the water option on the electronic display, press a glass against the dispensing paddle.

To stop dispensing water, pull the glass away from the water dispensing paddle. As the ice and water cut-off is not instant, leave glass under the dispenser until the ice and water has completely stopped to avoid spills.

A drip tray located at the base of the dispenser (see diagram above) will catch small spills and allow them to evaporate.

Opening the freezer door will de-activate the ice dispenser.

### **!** CAUTION

Do not pour water or excess cubes into the drip tray because it is not connected to a drain.

### **!** WARNING

Do not use fragile glass for dispensing water or ice – risk of injury from broken glass.

### **!** CAUTION

LED lighting

Your appliance is fitted with long life LED lighting. In the unlikely event the LED lights should fail, then the LED lights should be serviced by the manufacturer, its service agent or similarly qualified technician.

Refer to the warranty page for contact details.

## USING YOUR REFRIGERATOR

### Bottle filling function

The bottle filling function facilitates the flow of water directly into the mouth of a bottle, minimising splashing and spillage. Water flows from the water dispensing nozzle located on the underside of the ice and water dispenser.

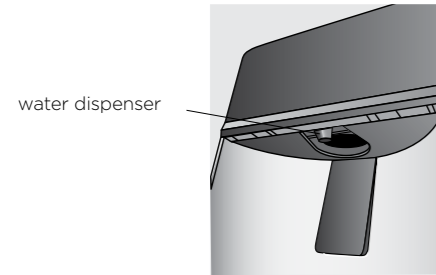

To use this function, place the mouth of the bottle over the water dispensing nozzle.

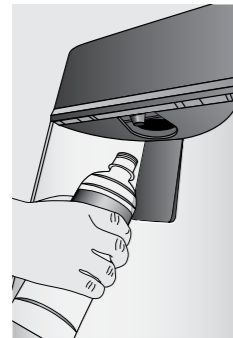

Once the mouth of the bottle is completely over the water dispensing nozzle (see diagram below) gently push bottle up to dispense water and fill bottle. Once the bottle is full, remove the bottle and the flow of water will stop automatically.

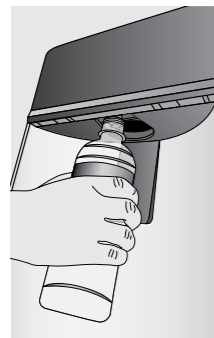

### Controlling the temperature

The default temperature for the refrigerator is 3°C and -18°C for the freezer. If you want to change the temperature, follow the instructions on the following pages.

Make only small adjustments and wait 24 hours to see if it's correct. Checking the softness of ice cream is a good indication of whether your freezer is at the correct temperature, while feeling the coldness of water kept in your refrigerator is a good way of checking the temperature of the food compartment.

*NOTE: The set temperature for the refrigerator is an average temperature for the whole refrigerator cabinet. Temperatures inside each compartment may vary depending on how much food you store and where you place it. High or low temperature may also affect the actual temperature inside the refrigerator.*

### Door alarm

Your new appliance is fitted with a door alarm. This alarm will sound if the refrigerator or freezer door is left open for longer than 3 minutes. To silence the alarm, check for any obstructions preventing the door from closing and remove or simply close the door.

## ABOUT THE USER INTERFACE

### Controls - Non ice and water refrigerator models

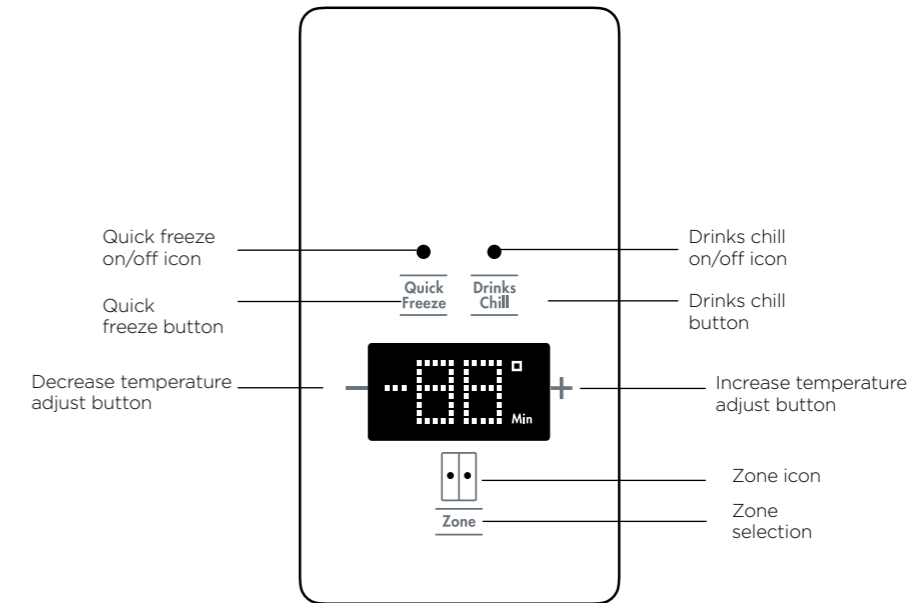

DESCRIPTION	OPERATION / PRIMARY FUNCTION
Quick Freeze on/ off icon	<ul style="list-style-type: none"> <li>Indicates the status of the Quick Freeze function.</li> </ul>
Quick Freeze button	<p>Use the Quick Freeze function when you add a large amount of food to the freezer compartment.</p> <ul style="list-style-type: none"> <li>Press the 'Quick Freeze' button. The Quick Freeze icon will flash indicating that the quick freeze is active and the compressor will run continuously for 90 minutes.</li> <li>After 90 minutes the freezer will automatically return to normal mode.</li> <li>The Quick Freeze function can be cancelled anytime by pressing the button again.</li> </ul>
Drinks Chill on/off icon	<ul style="list-style-type: none"> <li>Indicates the status of the Drinks chill function.</li> </ul>
Drinks Chill button	<p>Sets a timer for between 1 and 30 minutes as a reminder for when drinks are placed in the freezer for quick chill.</p> <ul style="list-style-type: none"> <li>To turn on press the drinks chill button an initial time of 20 mins will appear on the digital display. To adjust time use the '+' and '-' buttons.</li> <li>An alarm will sound when time is finished.</li> <li>Press the drinks chill button to turn off during or after countdown. The time taken to chill depends on the size of your bottle.</li> </ul> <p>Do not leave the bottle inside the freezer longer than the time needed for chilling.</p>
Digital display	<ul style="list-style-type: none"> <li>Indicates the temperature setting of the refrigerator compartment.</li> <li>Indicates the temperature setting of the freezer compartment.</li> </ul>
Temperature adjust buttons	<ul style="list-style-type: none"> <li>Touch any button to awaken control.</li> <li>Touch the '-' button to decrease or the '+' button to increase the selected compartment temperature.</li> <li>Once the coldest temperature is reached the display will return to the warmest setting with the next press.</li> </ul>
Zone Icon	<ul style="list-style-type: none"> <li>Indicates the selected zone.</li> </ul>
Zone select button	<ul style="list-style-type: none"> <li>Press to select the desired compartment.</li> <li>The refrigerator / freezer indication icon will show which zone is selected and the digital display will show the currently set temperature for that compartment.</li> </ul>

### IMPORTANT

If you want to change the temperature, remember to make only small adjustments and wait 24 hours to see if it's correct.



## ABOUT THE USER INTERFACE

### Controls - ice and water model

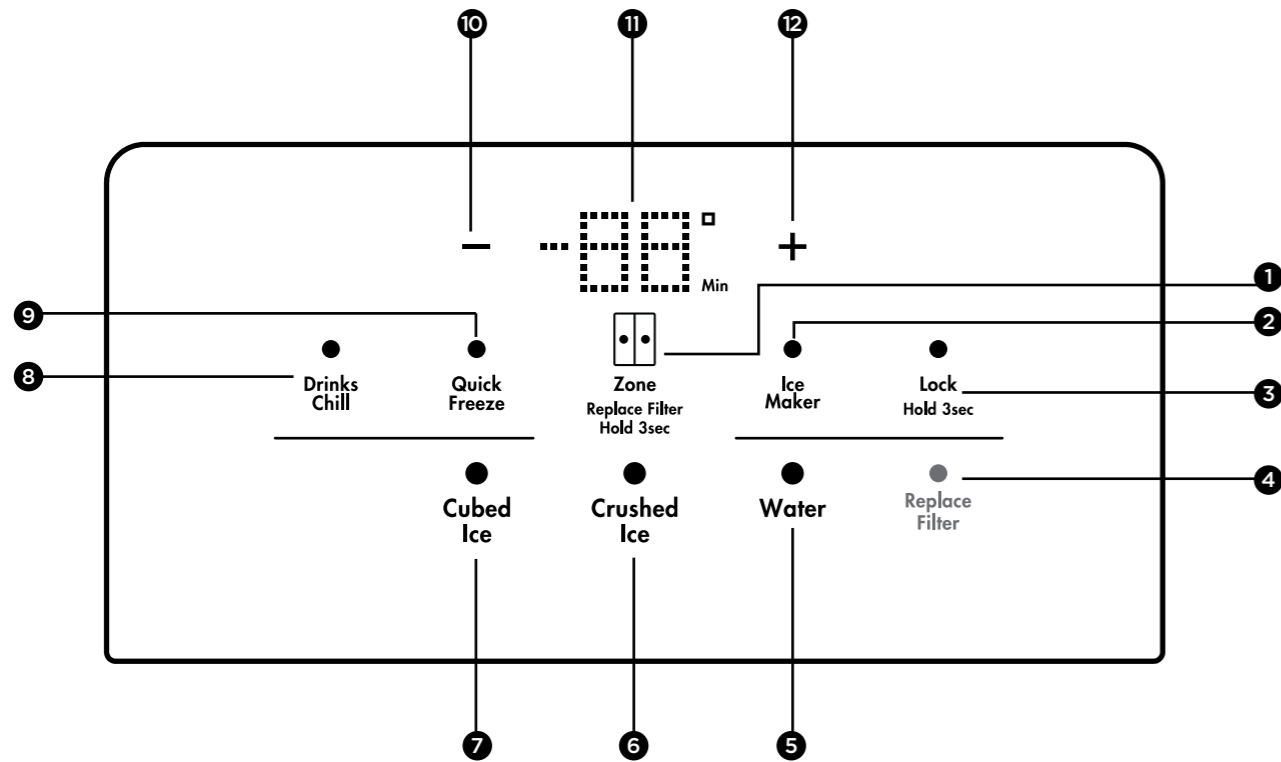

BUTTON / ICON	DESCRIPTION	PRIMARY FUNCTION
1	Compartment Selector button	Selects controllable compartment.
2	Ice & Water on/off button	Selects operational status.
3	Lock Icon	Indicates if the user interface is locked.
4	Filter status indicators	Indicates filter replacement timing.
5	Water on/off button	Selects operational status.
6	Crushed Ice Button	Selects crushed ice.
7	Cube Ice button	Selects cubed ice.
8	Drinks Chill button	Selects drinks chill timer.
9	Quick freeze button	Enables quick freeze model.
10	Decrease button	Decreases temperature of selected compartment.
11	Digital display	Indicates temperature of selected compartment.
12	Increase button	Increases temperature of selected compartment.

### **i** IMPORTANT

The factory default settings for the refrigerator is "3°" and "-18°C" for the freezer. If you want to change the temperature, remember to make only small adjustments and wait 24 hours to see if it's correct.

## FUNCTIONS OF THE USER INTERFACE

### ice and water model

FUNCTION	ICON	OPERATION
Setting the freezer temperature		<ul style="list-style-type: none"> <li>Press button 1 until freezer is displayed on icon 1.</li> <li>Press buttons 10 or 12 to adjust temperature up or down.</li> </ul>
Setting the refrigerator temperature		<ul style="list-style-type: none"> <li>Press button 1 until the refrigerator is displayed on icon 1.</li> <li>Press buttons 10 or 12 to adjust temperature up or down.</li> </ul>
Quick freeze mode Decreases the freezer temperature to -23°C for 12 hours before returning to pre-set mode.		<ul style="list-style-type: none"> <li>Press button 9 until the freeze icon is illuminated.</li> <li>Quick freeze mode can be deselected using button 9.</li> </ul>
Ice Maker Enables/disables ice making features.		<ul style="list-style-type: none"> <li>To enable/disable press button 2.</li> </ul>
Display Lock Deactivates the user interface controls.		<ul style="list-style-type: none"> <li>To turn on/off press and hold button 3 for 3 seconds, the lock icon is illuminated when activated.</li> </ul>
Drinks Chill Sets a timer for between 1 and 30 minutes as a reminder for when drinks are placed in the freezer for quick chill.		<ul style="list-style-type: none"> <li>To turn on press button 8 and initial time of 20 mins will appear on digital display. To adjust time use buttons 10 and 12.</li> <li>Alarm will sound when time is finished.</li> <li>Press button 8 to turn off during or after countdown. The time taken to chill depends on the size of your bottle.</li> <li>Do not leave the bottle inside the freezer longer than the time needed for chilling.</li> </ul>
Water on/off Enables/disables water dispensing features.		<ul style="list-style-type: none"> <li>To enable/disable press button 5.</li> </ul>
Cubed Ice Press this button to dispense cubed ice.		<ul style="list-style-type: none"> <li>Press button 6 for cubed ice to dispense.</li> <li>Press the dispenser lever to dispense the ice.</li> </ul>
Crushed Ice Press this button to dispense crushed ice.		<ul style="list-style-type: none"> <li>Press button 7 for crushed ice to dispense.</li> <li>Press the dispenser lever to dispense the ice.</li> </ul>
Replace Filter Press this button to reset the filter timer once you have replaced the filter.		<ul style="list-style-type: none"> <li>Button and icon 4 will initially display as Orange to indicate a new filter should be ordered.</li> <li>Button and icon 4 will turn red when the filter needs to be changed.</li> <li>Pressing button 4 will reset the change filter timer.</li> </ul>



## CLEANING YOUR REFRIGERATOR



### WARNING

**BEFORE CLEANING:** Turn the refrigerator off at the power point and unplug the cord to prevent any chance of electrocuting yourself.

#### Doors and exterior (white and silver):

You should only clean the doors with lukewarm soapy water and a soft cloth.

#### Stainless Steel:

Your stainless steel refrigerator is manufactured from mark-resistant stainless steel. This stainless steel has a special advanced protective coating that eases the removal of marks such as fingerprints and water spots. To keep its appearance, clean it regularly with lukewarm soapy water and a soft cloth.



### CAUTION

Never use stainless steel cleaners, abrasive pads or other cleaners that will scratch the surface. Damage to the appliance after delivery is not covered by your warranty.

#### Interior

Clean the inside of your refrigerator regularly with a soft cloth, unscented mild soap and lukewarm water. Thoroughly dry all surfaces and removable parts and avoid getting water on the controls. Replace removable parts, plug power cord in and switch the power on before returning the food.

#### Door seals

Always keep door seals clean by washing them with a mild detergent and warm water, followed by a thorough drying. Sticky food and drink can cause seals to stick to the cabinet and tear when you open the door.

Never use hot water, solvents, commercial kitchen cleaners, aerosol cleaners, metal polishes, caustic or abrasive cleaners, or scourers to clean your refrigerator. Many commercially available cleaning products and detergents contain solvents that will damage your refrigerator. Use only a soft cloth with an unscented mild soap and lukewarm water.



### CAUTION

To clean a crisper or freezer bin with telescopic extension slides, simply wipe with a damp cloth and warm soapy water. Never immerse the cover in water, as this could affect the operation of the slide.

#### Switching off your refrigerator

If you switch off your refrigerator for an extended period, follow these steps to reduce the chances of mould:

1. Remove all food.
2. Remove the power plug from the power point.
3. Thoroughly clean and dry the interior.
4. Ensure that all the doors are wedged open slightly for air circulation.

## FOOD STORAGE GUIDE

CATEGORY	PRODUCT	REFRIGERATOR	FREEZER	STORAGE TIPS
Meat	Sausages and Mince	1-2 Days	2-3 Months	Keep cold meat at the back of the refrigerator where it is coldest.
	Chops and Steak	3-4 Days	4-6 Months	
	Cold Meats	3-5 Days	4-6 Months	Plastic can cause meat to sweat if stored in refrigerator for more than a day.
Poultry	Cuts for roasting	3-5 Days	12 Months	Cuts for roasting can take up to 48 hours to defrost properly, transfer frozen cuts to the refrigerator 2 days before use.
	Chicken	1-2 Days	2 Months	If poultry takes on a smell or colour you are unsure about it is best to throw it out.
	Roast Chicken	3-5 Days	12 Months	
Seafood	Eggs	6 Weeks	Not Suitable	Whole eggs are not suitable for freezing, slightly beaten eggs may be frozen for four months.
	Whole fish and fillets	2-3 Days	2 Months	Store in an airtight container or foil.
	Lobster and crabs	1-2 Days	2 Months	Never freeze prawns in salty water as this will dehydrate the flesh.
Prawns	1-2 Days	2 Months		
Dairy	Milk	Until Expiry Date	Not Suitable	If dairy takes on a smell or colour and you are unsure about it, it is best to throw it out.
	Yoghurt	7- 10 Days	Not Suitable	
	Hard Cheeses	2 Weeks - 2 Months	2 Months (Grated)	Depending on the variety hard cheese can last from 2 weeks to 2 months.
	Soft Cheeses	1-2 Weeks	Not Suitable	
	Butter	8 Weeks	12 Months	
Fruit & Vegetables	Every fruit and vegetable has a different shelf life.		8-12 Months	Keep vegetables in the crisper and away from the air vents to avoid freezing. If you wash fruit and vegetables before storing them make sure they are dry or wrap in absorbent paper before storing in the refrigerator as this can make them susceptible to rotting. Try to keep fruit and vegetables separated as fruits that give off high levels of ethylene (the ripening agent) can prematurely ripen and spoil surrounding vegetables.
	Some stay fresh for a couple of days e.g. beans, others can last for a couple of months e.g. onions.		When freezing chop and blanch in small portions.	
Left Overs	Homemade meals	3-4 Days	2-6 Months	Store in sealed container. Freeze meals in small portion sizes to limit wastage.



### IMPORTANT

Please note, use this information as a guide only, actual storage times will vary depending on how you use your refrigerator, climatic conditions and the freshness of the food. Food should not be left uncovered in the refrigerator.

## TROUBLESHOOTING

### APPLIANCE DOES NOT OPERATE AT DESIRED TEMPERATURE

In a modern frost free refrigerator/freezer, cold air is circulated around the various compartments through air vents using a high efficiency fan.

CONCERN	WHAT TO DO
Refrigerator is too warm	Ensure food is allowed to cool before placing inside the refrigerator.
	Ensure the appliance is set up as per instructions on page 11.
	Ensure that contents are not obstructing the cooling vents.
	Ensure the door is not held open or is being opened too frequently.
Freezer is too warm	Adjust temperature to a colder setting.
	Ensure food is allowed to cool before placing inside the freezer.
	Ensure the appliance is set up as per instructions on page 11.
	Ensure that contents are not obstructing the cooling vents.
Food is freezing in the refrigerator	Ensure the door is not held open or is being opened too frequently.
	Adjust temperature to a warmer setting.
	Ensure that fruit and vegetables are stored in the crisper. Items with a high water content should not be placed near the cooling vents.
	Refer to function guide in the "User Interface" section.
Unable to change temperature settings	Ensure that user interface is in "awake" mode before trying to adjust temperature settings.

### APPLIANCE NOISE

Your new refrigerator may make sounds that your old one didn't make. Because the sounds are new to you, you might be concerned about them. Most of the new sounds are normal. Hard surfaces, like the floor, walls and cabinets, can make the sounds seem louder than they actually are. The following describes the kinds of sounds and what may be making them.

CONCERN	WHAT TO DO
Motor noise (compressor)	Nothing. This is normal as your new refrigerator uses a high-speed compressor which switches on and off during operation. Note that the compressor noise may seem louder at the start of the on cycle.
A clicking noise heard just before the compressor starts.	Nothing. This is normal as your new refrigerator has an automatic switching action of the temperature control, turning the compressor on and off.
Occasional gurgling, similar to water boiling.	Nothing. As each cycle ends, you may hear a gurgling sound due to the refrigerant flowing in your refrigerator system.
Airflow noise.	Nothing, this is normal as your new refrigerator uses high efficiency fans to circulate air.
Rattling and other noises.	Ensure that the cabinet is level and stable, refer to Installation Instructions on page 6.
	Check the surrounds of the appliance to ensure there is nothing touching or placed on top of the appliance.
	Ensure that contents of the appliance are not placed in such a way that they are vibrating (such as bottles).

### CRISPER OPERATION

CONCERN	WHAT TO DO
Excess moisture build up in crisper	Ensure that the crisper is not over packed.
It is normal for there to be some moisture and humidity in the crisper bin.	Adjust crisper humidity slides.
Crisper bin can not be removed	If crisper bin interferes with the door bins, remove door bins before removing crisper.
	Position cabinet so that the door can be fully opened.
Freezing items in the crisper	Adjust temperature to a warmer setting.

### REFRIGERATOR OPERATION

CONCERN	WHAT TO DO
Appliance will not run	Ensure that the cord is plugged into a live power outlet and outlet is switched on.
	It is normal for the freezer fan not to operate during the automatic defrost cycle, or for a short time after the appliance is switched on.
	Ensure that the household circuit breaker has not tripped or that the fuse has not blown. The appliance maybe in defrost mode, check again in half an hour.
Compressor motor seems to run too long	Ensure that the doors are not held open.
	Check that large amounts of warm food have not just been placed inside the appliance.
	Note that the appliance will run more than normal just after you install it or when adjusting to temperature setting changes.
The exterior of the appliance is warm or hot to touch	Ensure the appliance has the external clearances recommended in the section "Installing your new appliance".
	This is normal because the appliance transfers heat from the inside out through the outer panels and the divider between the doors. The exterior of the cabinet will be much warmer on warmer days it may even feel hot to touch, as the appliance is working harder.
User interface will not respond	Check that the user interface is in awake mode, refer to section "User interface".
	To ensure settings are not accidentally changed the user interface will go into sleep mode when not in use. Press any button to wake user interface
	Check that the user interface is not locked, refer to section "User interface". If the user interface is frozen turn the appliance off for five minutes for the memory to clear, then turn back on.
Alarms Sounding	Check that all doors are fully closed.
	Ensure that the over temperature alarm is not being activated by hot food placed in the freezer.
	Check if the drinks timer has ended, refer control instructions. Check if the Filter Replacement alert is activated, refer control instructions. (I&W models only)
Frost build up	Check that all doors are fully closed.
	Ensure that the doors are not opened too often.
	Ensure that the return air vents are not blocked with packaging. Ensure the seals are clean and not obstructed.
Odours	The interior may need cleaning, refer to cleaning guide.
	Ensure that food is stored correctly as some food, containers and wrapping can produce odours.
	Check appliance for old or unusual food.
Lights not working	Ensure that the cord is plugged into a live power outlet and outlet is switched on.
	The LED lighting is designed to turn on gradually.
	Ensure that the household circuit breaker has not tripped or that the fuse has not blown. Check the appliance features section to determine lighting configuration for your model.

## TROUBLESHOOTING

### DOOR OPERATION

CONCERN	WHAT TO DO
Self close not working.	Check if your appliance has self closing hinges as not all models do. It indicates that the appliance needs to be tilted backwards a little further. Refer to section "Installing your new appliance".
Door not sealing properly	Ensure there is nothing that is preventing the door from closing such as appliance contents or items placed near the appliance. Ensure that the crisper/freezer bin is closed completely and that nothing is preventing it from closing. Ensure the appliance is set up as per recommendations.
Door difficult to open and close	If the door is difficult to open just after you have closed it this is due to the pressure equalising, the door will open normally after a few minutes.

### AUTOMATIC ICE MAKER

PROBLEM	POSSIBLE CAUSES	SOLUTION
The ice maker is not making any ice	• Ice maker is turned OFF.	• See Ice maker section in user manual: turn switch to ON position.
	• Water tap is turned off	• Turn on the water tap.
	• The freezer is not cold enough	• See the Problem section: 'If the temperature in the refrigerator is too warm'.
	• The water dispenser may not be dispensing water	• If it isn't, the ice & water filter cartridge may be clogged or restricted by foreign material, and will need to be replaced.
	• Filter may be blocked	• Check and/or change filter.
The ice-maker is not making enough ice	• The ice maker is producing less ice than you expect	• The ice maker should produce approximately 0.5-1 kilogram of ice every 24 hours.
	• The freezer is not cold enough	• See section 'User Interface'.
	• Household water tap is not open	• Open the household water tap.
	• The water dispenser is dispensing slower than normal	• Replace the water filter cartridge.
Ice cubes are too small or too big	• Restricted water flow to the ice maker	• Replace the filter cartridge, as the water filter cartridge may be clogged.
	• Water pressure may be too low	• Check water supply hose for kinks.
	• Water pressure may be too high	• Check water pressure meets minimum and maximum requirement (see install instructions).
	• Appliance not levelled correctly	
The ice has a bad odour and taste	• The ice has picked up odour or flavour from strongly flavoured food stored in the refrigerator or freezer	• Cover foods tightly. Discard stale ice. The ice maker will produce a fresh supply. • Change ice monthly.
	• The water running into the ice maker has poor taste or colour	• Add or replace water filter to water supply. Consult a water purifying company.
	• Ice not used frequently enough	• Discard stale ice monthly.

### ICE DISPENSER

PROBLEM	POSSIBLE CAUSES	SOLUTION
The dispenser will not dispense ice	• The ice storage container is empty	• Refer 'the ice maker is not making any ice' section above.
	• The ice chute is blocked	• The first supply of ice may take up to 4 hours after power up, try the dispenser after ice is made.  • Remove ice bin to gain access to chute underneath and remove any ice causing the blockage. Dry the surface of the chute with a paper towel or similar and replace the ice bin ensuring it is fully seated on the door.  • Make sure cups are not over filled with ice during use, causing ice to be trapped in chute.
The ice dispenser is jammed	• Ice has melted and frozen around the stirrer or in the crusher due to infrequent use, temperature fluctuations and/or power outages.	• Remove the ice bin and empty its contents. Use warm water to melt any ice in the bin and crusher. Leave to dry completely so water does not refreeze in the bin causing a further blockage and refit. Make sure the bin is fully seated on the door. When new ice is made the dispenser should operate.
	• Ice cubes are hollow or smaller than normal	• The water filter cartridge could be clogged. • Cartridge may need replacing.
Water leaking from ice dispenser	• Ice trapped and melting in ice chute	• Clear ice chute of ice.
	• Ice cubes too small and falling into ice dispenser	• Check ice cube size (refer to the 'Adjusting ice cube size' section).
The flap on the ice dispenser does not close properly	• Ice cubes are preventing the flap from closing properly	• Remove ice bin to gain access to the ice chute and remove ice cubes from chute.

#### If you still require service

If you have a problem, and the problem persists after you have made the checks mentioned, contact your nearest Electrolux approved Service Centre or the dealer you bought the refrigerator from. Be ready to quote the model number, the 9-digit PNC and 8-digit serial number, which is stated on the label inside the refrigerator compartment.





**For more information on all Westinghouse appliances, or for dimension and installation information, call into your retailer, phone or email our customer care team or visit our website:**

**AUSTRALIA**

phone: 13 13 49

email: [customercare@electrolux.com.au](mailto:customercare@electrolux.com.au)

web: [westinghouse.com.au](http://westinghouse.com.au)

**NEW ZEALAND**

phone: 0800 10 66 10

email: [customercare@electrolux.co.nz](mailto:customercare@electrolux.co.nz)

web: [westinghouse.co.nz](http://westinghouse.co.nz)

 and WESTINGHOUSE are trademarks of Westinghouse Electric Corporation.  
Used under license by Electrolux Home Products Pty Ltd. All Rights Reserved.

ANC No. A05086301

© 2020 Electrolux Home Products Pty Ltd.  
ABN 51 004 762 341  
WMAN\_MLSxS\_Mar20