



Westinghouse

user manual

Tumble Dryer

WDH804N8WA

Electrolux. Thinking of you.

Westinghouse. We are part of the Electrolux family.

Share more of our thinking at www.electrolux.com**CONTENTS**

Safety information	2	Before first use	14
Conditions of Use	5	Daily use	15
Safety instructions	5	Hints and tips	16
Product Description	7	Care and cleaning	17
Control Panel	8	Troubleshooting	19
Program table	9	Technical Data	21
Options	11	Warranty	22
Settings	12	Environmental concerns	24

Subject to change without notice.

 SAFETY INFORMATION

Before the installation and use of the appliance, carefully read the supplied instructions. The manufacturer is not responsible if an incorrect installation and use causes injuries and damage. Always keep the instructions with the appliance for future reference.



- Read the supplied instructions.



Warning: Risk of fire / Flammable materials.

The appliance contains flammable gas, propane (R290), a gas with a high level of environmental compatibility. Keep fire and ignition sources away from the appliance. Be careful not to cause damage to the refrigerant circuit containing propane.

Children and vulnerable people safety**WARNING!**

Risk of suffocation, injury or permanent disability.

- This appliance can be used by children aged from 8 years and above and persons with reduced physical, sensory or mental capabilities or lack of experience and knowledge if

they have been given supervision or instruction concerning the use of the appliance in a safe way and understand the hazards involved.

- Children between 3 and 8 years of age and persons with very extensive and complex disabilities shall be kept away from the appliance unless continuously supervised.
- Children of less than 3 years of age should be kept away from the appliance unless continuously supervised.
- Do not let children play with the appliance.
- Keep all packaging away from children and dispose of it appropriately.
- Keep detergents away from children.
- Keep children and pets away from the appliance when the door is open.
- If the appliance has a child safety device, it should be activated.
- Children shall not carry out cleaning and user maintenance of the appliance without supervision.

General Safety

- Do not change the specification of this appliance.
- The appliance can be installed as freestanding or below a kitchen counter with correct space (refer to the Installation leaflet).
- Do not install the appliance behind a lockable door, a sliding door or a door with a hinge on the opposite side, that would prevent the appliance door from being fully open.
- The ventilation opening in the base must not be covered by a carpet, mat, or any floor covering.
- **WARNING:** The appliance must not be supplied through an external switching device, such as a timer, or connected to a circuit that is regularly switched on and off by a utility.
- Connect the mains plug to the mains socket only at the end of the installation process. Make sure that the mains plug is accessible after installation.

- Ensure good air ventilation in the room where the appliance is installed to avoid the backflow of unwanted gases into the room from appliances burning gas or other fuels, including open fires.
- **WARNING:** Do not install the appliance in an environment with no air exchange.
The appliance contains flammable gas, propane (R290), a gas with a high level of environmental compatibility. Keep fire and ignition sources away from the appliance. Be careful not to cause damage to the refrigerant circuit containing propane.
- **WARNING:** In the appliance enclosure or in the built-in structure, keep ventilation opening clear of obstruction.
- **WARNING:** Do not damage the refrigerant circuit.
- If the mains power supply cable is damaged, it must be replaced by the manufacturer, its Authorised Service Centre or similarly qualified persons to avoid an electrical hazard.
- Do not exceed the maximum load of 8 kg (refer to the "Programme chart" chapter).
- Do not use the appliance if items have been soiled with industrial chemicals.
- Wipe away lint or packaging debris that has accumulated around the appliance.
- Do not run the appliance without a filter. Clean the lint filter before or after each use.
- Do not dry unwashed items in the tumble dryer.
- Items that have been soiled with substances such as cooking oil, acetone, alcohol, petrol, kerosene, spot removers, turpentine, waxes and wax removers should be washed in hot water with an extra amount of detergent before being dried in the tumble dryer.
- Items such as foam rubber (latex foam), shower caps, waterproof textiles, rubber backed articles and clothes or pillows fitted with foam rubber pads should not be dried in the tumble dryer.

- Fabric softeners, or similar products, should only be used as specified by the product manufacturer's instructions.
- Oil-affected items can ignite spontaneously, especially when exposed to heat sources such as in a tumble dryer. The items become warm, causing an oxidation reaction in the oil. Oxidation creates heat. If the heat cannot escape, the items can become hot enough to catch fire. Piling, stacking or storing oil-affected items can prevent heat from escaping and create a fire hazard.
- If it is unavoidable that fabrics that contain vegetable or cooking oil or have been contaminated by hair care products be placed in a tumble dryer they should first be washed in hot water with extra detergent -this will reduce, but not eliminate, the hazard.
- Remove all objects from items that could be a source of fire ignition such as lighters or matches.
- **WARNING:** Never stop a tumble dryer before the end of the drying cycle unless all items are quickly removed and spread out so that the heat is dissipated.
- Before any maintenance operation, deactivate the appliance and disconnect the mains plug from the socket.

CONDITIONS OF USE

This appliance is intended to be used in household and similar applications such as:

- farm houses;
- by clients in hotels, motels, bed & breakfast and other residential type environments;

- areas for communal use in blocks of flats or in launderettes.

SAFETY INSTRUCTIONS

Installation



Warning: Risk of fire / Flammable materials.

- Remove all the packaging.
- Do not install or use a damaged appliance.
- Follow the installation instructions supplied with the appliance.
- Do not install the appliance in an environment with no air exchange. The appliance contains flammable gas, propane (R290), a gas with a high level of environmental compatibility. Keep fire and ignition sources away from the appliance. Be careful not to cause

damage to the refrigerant circuit containing propane.

- Always take care when moving the appliance as it is heavy. Always use safety gloves and enclosed footwear.
- Do not install or use the appliance where the temperature can be lower than 5°C or higher than 35°C.
- The floor area on which the appliance is to be installed must be flat, stable, heat resistant and clean.
- Make sure that there is air circulation between the appliance and the floor.
- Always keep the appliance vertical when it is being moved.
- The rear surface of the appliance must be put against a wall.
- When the appliance is in its permanent position, check if it is levelled correctly with the aid of a spirit level. If it is not, adjust the feet accordingly.

Electrical connection



WARNING! Risk of fire and electric shock.

- Connect the mains plug to the mains socket only at the end of the installation. Make sure that there is access to the mains plug after the installation.
- The appliance must be earthed.
- Make sure that the parameters on the rating plate are compatible with the electrical ratings of the mains power supply.
- Always use a correctly installed shockproof socket.
- Do not use multi-plug adapters and extension cables.
- Do not pull the mains cable to disconnect the appliance. Always pull the mains plug.
- Do not touch the mains cable or the mains plug with wet hands.

Use



WARNING! Risk of injury, electric shock, fire, burns or damage to the appliance.



Warning: Risk of fire / Flammable materials. The appliance contains flammable gas, propane (R290), a gas with a high level of environmental compatibility. Keep fire and ignition sources away from the appliance. Be careful not to cause damage to the refrigerant circuit containing propane.

- This appliance is for household (indoors) use only.
- Do not dry damaged (torn, frayed) items that contain padding or fillings.
- If laundry has been washed with a stain remover, carry out an additional rinse cycle before starting a drying cycle.
- Dry only fabrics that are suitable to dry in the appliance. Follow the cleaning instruction on the item label.
- Do not drink or prepare food with the condensed water/distilled water. It can cause health problems to people and pets.
- Do not sit or stand on the open door of the appliance.
- Do not dry dripping wet clothes in the appliance.

Internal lighting



WARNING! Risk of injury.

- Visible LED radiation, do not look directly into the beam.
- To replace the internal lighting, contact the Authorised Service Centre.

Care and cleaning



WARNING! Risk of injury or damage to the appliance.



Warning: Risk of fire / Flammable materials. The appliance contains flammable gas, propane (R290), a gas with a high level of environmental compatibility. Keep fire and ignition sources away from the appliance. Be careful not to cause damage to the refrigerant circuit containing propane.

- Do not use water spray and steam to clean the appliance.
- Clean the appliance with a moist soft cloth. Use only neutral detergents. Do not use abrasive products, abrasive cleaning pads, solvents or metal objects.
- Be careful when you clean the appliance to prevent damage to the cooling system.

Compressor



WARNING! Risk of damage to the appliance.

- The compressor and its system in the tumble dryer is filled with a special agent which is free from fluoro-chloro-hydrocarbons. This system must stay tight. The damage of the system can cause a leakage.

Service

- To repair the appliance contact the Authorised Service Centre.
- Use original spare parts only.

Disposal



WARNING! Risk of injury or suffocation.



Warning: Risk of fire / Risk of material damage and damage to the appliance.

- Disconnect the appliance from the mains electrical and water supplies.
- Cut off the mains electrical cable close to the appliance and dispose of it.
- The appliance contains flammable gas (R290). Contact your municipal authority for information on how to discard the appliance correctly.
- Remove the door catch to prevent children or pets from becoming trapped in the drum.
- Dispose of the appliance in accordance with local requirements for the disposal of Waste Electrical and Electronic Equipment (WEEE).

PRODUCT DESCRIPTION

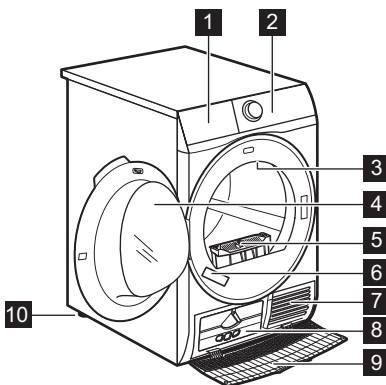

- 1 Water container
- 2 Control panel
- 3 Internal light
- 4 Appliance door
- 5 Filter
- 6 Rating plate
- 7 Airflow slots
- 8 Heat Exchanger lid
- 9 Heat Exchanger cover
- 10 Adjustable feet



For ease of loading laundry or ease of installation the door is reversible. (see separate leaflet).

CONTROL PANEL

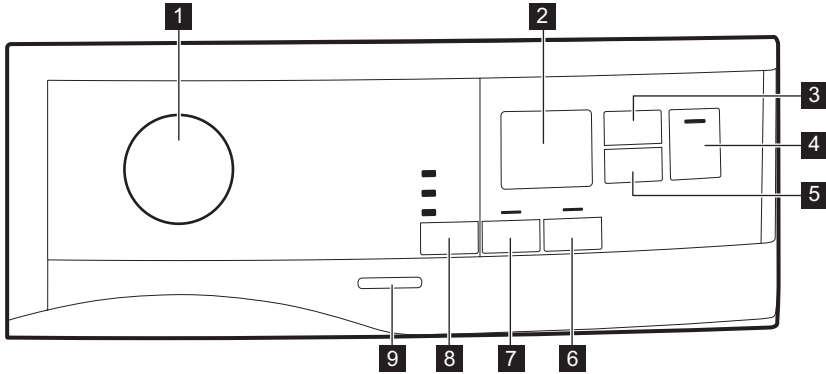

- 1** Programme knob
- 2** Display
- 3** Time Dry touch button
- 4** Start/Pause touch button
- 5** Delay Start touch button
- 6** Extra Anticrease touch button
- 7** Reverse Plus touch button
- 8** Dryness Level touch button

9 On/Off button









Press the touch buttons with your finger in the area with the symbol or name of the option. Do not wear gloves when you operate the control panel. Make sure that the control panel is always clean and dry.















Display







Symbol on the display	Symbol description
	time drying option on
	delay start option on
	indicator: <i>check Heat Exchanger</i>

Symbol on the display	Symbol description
	indicator: <i>clean filter</i>
	indicator: <i>drain the water container</i>
	indicator: <i>drying phase</i>
	indicator: <i>cooling phase</i>
	indicator: <i>anti-crease phase</i>
	child lock on
	wrong selection
2 : 0 0	program duration
: 1 0 - 2 : 0 0	time Drying duration
1 h - 2 0 h	delay start duration

PROGRAM TABLE

Program	Load ¹⁾	Properties / Fabric type ²⁾	
Favourite ☆	Depends on a memorised program	You can do your configuration of program and options and memorise in the appliance memory (See chapter " <i>Settings - Favourite ☆</i> ").	
Cotton	8 kg	Cotton fabrics.	/  
Mixed	3kg	Cotton and synthetic fabrics. Low temperature program. Delicate program with warm air.	/   
Bedding	3kg	Bed linen such as single and double sheets, pillowcases, duvet cover.	/   
Synthetic	3,5 kg	Synthetic and mixed fabrics.	/   
 Eco Cotton³⁾	8 kg	Cycle to be used to dry cotton with "cotton cupboard" dryness level, with maximum energy saving.	/  

Program	Load ¹⁾	Properties / Fabric type ²⁾	
Drying Rack ⁴⁾	1kg (or 1 pair of sport shoes)	For drying sport shoes only with Drying Rack (see separate user manual provided with Drying Rack).	
Denim	4 kg	Leisure clothing such as jeans, sweat-shirts of different material thicknesses (e.g. at the neck, cuffs and seams).	/   
Gym Wear	2 kg	Sportswear, thin and light fabrics, microfiber, polyester.	/   
Easy Iron	1 kg (or 5 shirts)	Easy care fabrics for which a minimum of ironing is necessary. The drying results can be different from one type of fabric to another. Shake the items before putting them in the appliance. When the program has ended, immediately remove the items and put them on a hanger.	/   
Shirts	1,5kg (or 7 shirts)/	Easy care fabrics for which a minimum of ironing is necessary. The drying results can be different from one type of fabric to the other. Shake the items before you put them in the appliance. When the program is completed, immediately remove the items and put them on a hanger.	/   
Wool	1 kg	Woollen fabrics. Gentle drying for hand-washable woollens. Remove items immediately when the program is completed.	
Delicates	4 kg	Delicate fabrics such as viscose, rayon, acrylic, and their blends.	/   

¹⁾ The maximum weight refers to dry items.

²⁾ For fabric mark meaning see chapter HINTS AND TIPS: Preparing the laundry.



³⁾  Eco Cotton program is the reference program for Energy Label, tested according to AS/NZS2442.2.

⁴⁾ Only with the Drying Rack (standard accessory or optional, depending on model).

OPTIONS

Dryness Level

This function helps to increase dryness of the laundry. There are 3 options:

-  Extra Dry
-  Cupboard Dry
-  Iron Dry

Reverse Plus

Increase drum reversing frequency to reduce items twisting and entanglement. To increase uniformity of drying result and help reduce creases. Recommended for large or long items (e.g. sheets, trousers, long dresses)"

Extra Anticrease

Extends the anti-crease phase by 60 minutes at the end of the drying cycle. This function reduces creases. The laundry can be removed during the anti-crease phase.

Time Dry

You can set the program duration, from a minimum of 10 minutes to a maximum of 2 hours. The required duration is related to the quantity of laundry in the appliance.



We recommend that you set a short duration for small quantities of laundry or for only one item.

TIME DRYING RECOMMENDATION	
10 - 20 min	action of cool air only (no heater).
20 - 40 min	additional drying to improve dryness after previous drying cycle.
>40 min	full drying of the small laundry loads up to 4 kg, well spun (>1200 rpm).



Time Dry on Drying Rack program

Option suitable for Drying Rack program .

You can set the program duration, from a minimum of 10 minutes to a maximum of 2 hours. The setting of the duration is related to the quantity of laundry in the appliance.

We recommend that you set a short duration for small quantities of laundry or for only one item.

Options table

Program ¹⁾	Dryness Level			Reverse Plus	Extra Anti-crease	Time Dry
						
Favourite ☆	Depends on a memorised program					
Cotton	■	■	■	■	■	■
Mixed		■			■	■
Bedding		■			■	

Program ¹⁾	Dryness Level			Reverse Plus	Extra Anti-crease	Time Dry
Synthetic	■	■	■	■	■	■
 Eco Cotton		■			■	
Drying Rack						■
Denim	■	■		■	■	
Gym Wear		■			■	
Easy Iron			■		■	
Shirts			■		■	
Wool						■
Delicates		■			■	

¹⁾ Together with the program you can set 1 or more options. To activate or deactivate them, press the related touch button.

SETTINGS

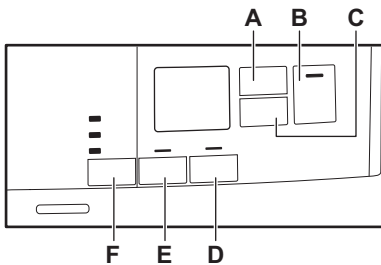

- A. Time Dry touch button
- B. Start/Pause touch button
- C. Delay Start touch button
- D. Extra Anticrease touch button
- E. Reverse Plus touch button
- F. Dryness Level touch button

Child lock function

This option prevents children playing with the appliance while a program is operating. The touch buttons are locked.

Only the on/off button is unlocked.

Activating the child lock option:

1. Press the on/off button to activate the appliance.

2. Press and hold touch button (D) for a few seconds.

The child lock indicator comes on.



It is possible to deactivate the child lock option while a program operates. Press and hold the same touch buttons until the child lock indicator goes off. The Child Lock function isn't available for 8 s after switching on the appliance.

Favourite ☆

You can do your configuration of program and options and memorise in the appliance memory.

To memorise your configuration:

1. Press the on/off button to activate the appliance
2. Set the program and available options.
3. Press the (E) button for some seconds.

The sound and the message on the display confirm that the configuration is memorised.

To activate your memorised configuration:

1. Press the on/off button to activate the appliance.
2. Use the program knob to set Favourite ☆ position.

Previously memorised configuration of program and options will be restore.

Adjustment of remaining laundry moisture

The appliance allows you to chose between 3 levels corresponding to different ranges of water hardness.

Dryness level	ppm	the results from the included water hardness kit.
- 0 -	< 150	C01-C03
- 1 -	150 - 300	C04-C05
- 2 -	> 300	C06-C07

Depending on the country, the water hardness is expressed in equivalent scales: e.g. French degrees (°f), German degrees (°d), English degrees (°e), mmol/l and ppm

If necessary, please contact your local water authority to check the water hardness in your area.

-  Every time you enter in the "Adjustment of remaining laundry moisture" mode, previously set degree of remaining moisture will change into next value (e.g previously set - 2 - will change into - 1 -).

To change the default degree of remaining moisture:

1. Press the on/off button to activate the appliance.
2. Use the program knob to set any program.
3. Wait approximately 8 seconds.
4. Press and hold buttons (E) and (D) at the same time.

One of these indicators comes on:

- - 0 - the maximum dryness
- - 1 - the more dry laundry
- - 2 - the standard dry laundry

5. Press and hold buttons (E) and (D) again until the indicator of the correct level comes on.

-  If the display returns to the normal mode (the time of the selected program from step 2. will be displayed), while setting the degree of remaining moisture, press and hold buttons (E) and (D) once again to enter to the "Adjustment of remaining laundry moisture" mode (previously set degree of remaining moisture will change into next value).

6. After 5 s the display returns to normal mode.

Water container indicator

By default, the water container indicator is on. It comes on when the program is completed or when it is necessary to empty the water container.

-  If a draining kit is installed (additional accessory), the appliance automatically drains the water from the water container. In this case we recommend that you deactivate the indicator of the water container.

Deactivating the water container indicator:

1. Press the on/off button to activate the appliance.
2. Wait approximately 8 seconds.
3. Press and hold touch buttons (A) and (C) at the same time.

The display shows one of these 2 configurations:

- The display shows "Off". After 5 s the display returns to normal mode.
- The display shows "On". After 5 s the display returns to normal mode.

Buzzer on/off

To deactivate or activate the acoustic signals, press and hold for approximately 2 seconds touch buttons (E) and (F) at the same time.

BEFORE FIRST USE

- i** Rear drum locks are removed automatically when dryer is activated for the first time. Possible to hear some noise.

- i** It is highly recommended to start any program for the first time without the load for a few seconds to ensure that the rear drum locks are removed properly.

To unlock the rear drum locks:

1. Switch on the appliance.
 2. Set any program.
 3. Press the Start/Pause button.
- Drum starts to rotate. Rear drum locks are automatically deactivated.

- i** If the drum still does not rotate, please release the rear drum locks manually (to do that, please use provided key).

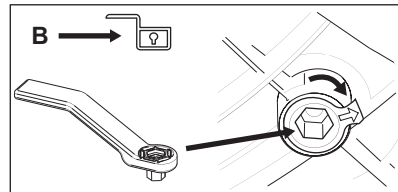
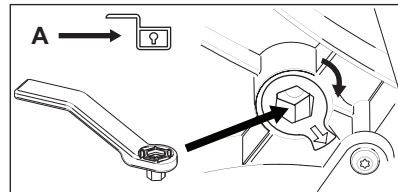

Before you use the appliance to dry items:

- Clean the tumble dryer drum with a moist cloth.
 - Start a 1 hour program with moist laundry.
- i** At the beginning of the drying cycle (first 3-5 min) there could be a slightly higher sound level. This is due to the compressor starting up. This is normal for compressor powered appliances such as refrigerators and freezers.

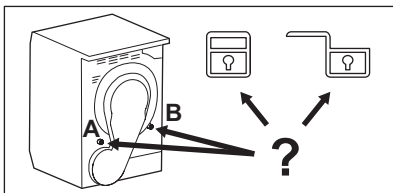

DAILY USE

Start a program without delay start

1. Prepare the laundry and load the appliance.

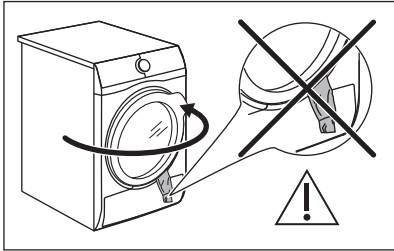

CAUTION! Make sure that when you close the door, the laundry does not get caught between the appliance door and the rubber seal.

2. Press the on/off button to activate the appliance.
3. Set the correct program and options for the type of load.

The display shows the program duration.



Real drying time will depend on type of the load (quantity and composition), the room temperature and the humidity of your laundry after spin drying phase.

4. Press the Start/Pause touch button. The program starts.

Starting the program with delay start

1. Set the correct program and options for the type of load.
2. Press the delay start button again and again until the display shows the delay time you want to set.



You can delay the start of a program from a minimum of 30 minutes to a maximum of 20 hours.

3. Press the Start/Pause touch button.

The display shows the countdown of the delay start.

When the countdown is completed, the program starts.

Change a program

1. Press the on/off button to deactivate appliance
2. Press the on/off button to activate the appliance.
3. Set the program.

At the end of the program

When the program is completed:

- An intermittent acoustic signal operates.
- The display shows :
- The indicator is on.
- The indicators Filter and Tank may come on.
- The Start/Pause indicator is on.

The appliance continues to operate with the anti-crease phase for approximately 30 minutes or more if Extra Anticrease option was set (see chapter *Option - Extra Anticrease*).

The anti-crease phase reduces creasing.

You can remove the laundry before the anti-crease phase is completed. We recommend, for better results, that you remove the laundry when the phase is almost completed.

When the anti-crease phase is completed:

- The display still shows :
- The indicator is off.
- The indicators Filter and Tank remain on.
- Start/Pause indicator goes off.

1. Press the on/off button to deactivate the appliance.
2. Open the appliance door.
3. Remove the laundry.
4. Close the appliance door.

Possible causes of unsatisfactory drying results:

- Inadequate default dryness level settings. See chapter *Adjustment of default dryness level*
- Room temperature is too low or too high. Optimal room temperature is between 18°-25°C.



Always clean the filter and empty the water container when a program is completed.

Stand-by function

To reduce energy consumption, this function automatically deactivates the appliance:

- After 5 minutes if you do not start the program.
- After 5 minutes from the end of the program.

HINTS AND TIPS

Preparing the laundry







Very often the clothes after washing cycle are kneaded and tangled altogether.

Drying kneaded and tangled clothes is inefficient.

To assure proper air flow and even drying it is recommended to shake and load one by one the clothes to the tumble dryer.

To assure proper drying process:

- Close the zips.
- Close the fasteners of duvet covers.
- Do not dry ties or ribbons loose (e.g. apron ribbons). Tie them before you start a program.
- Remove all items from pockets.
- Turn items with the internal layer made of cotton inside out. Cotton layer must be faced outwards.
- Always set the program suitable for the type of laundry.
- Do not put light and dark colours together.
- Use suitable program for cottons, jersey and knitwear to reduce shrinkage.
- Do not exceed the maximum load stated in the programs chapter or shown on the display.
- Dry only the laundry that is suitable for tumble drying. Refer to the fabric label on the items.
- Do not dry large and small items together. Small items can be trapped inside the large items and remain wet.
- Shake the large clothes, fabrics before placing in the tumble dryer. It is to avoid moist places inside the fabric after the drying cycle.

Fabric label	Description
	Laundry is suitable for tumble drying.
	Laundry is suitable for tumble drying at higher temperatures.
	Laundry is suitable for tumble drying at low temperatures only.
	Laundry is not suitable for tumble drying.

CARE AND CLEANING

Cleaning the filter



CAUTION! Avoid the use of water to clean the filter. Instead throw away lint in the dustbin (avoid dispersion of plastic fiber in water ambient).



To achieve the best drying performances clean the filter regularly , clogged filter lead to longer cycles and energy consumption increase. Use your hand to clean the filter , and if necessary , a vacuum cleaner .

1.

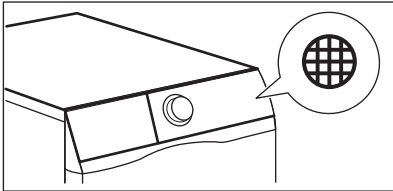

2.

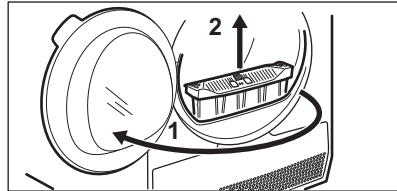

3.

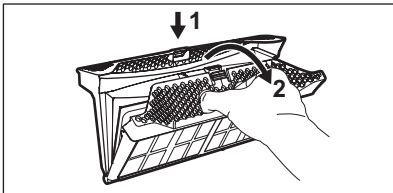

4.

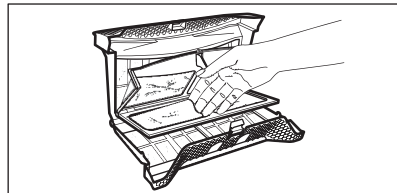

5. 1)

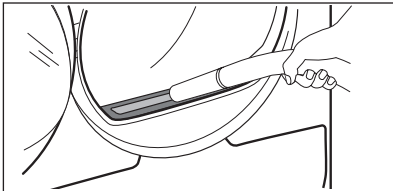

6.

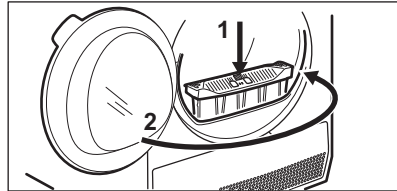

1) If necessary remove fluff from the filter socket and gasket. You can use a vacuum cleaner.

Emptying the water container

1.

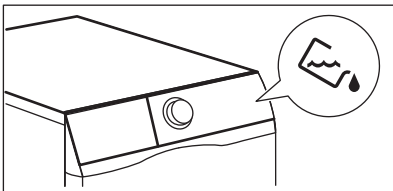

2.

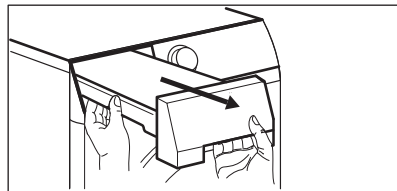

3.

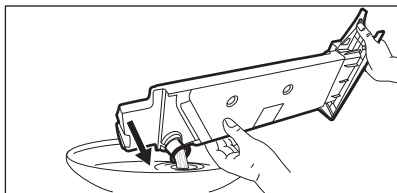

4.

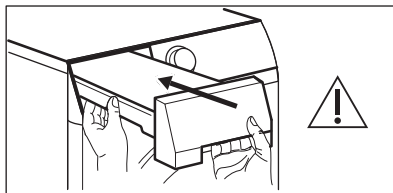

You can use the water from the water container as an alternative to distilled water (e.g. for steam ironing). Before you use the water, remove dirt residues with a filter.

Cleaning the Heat Exchanger

1.

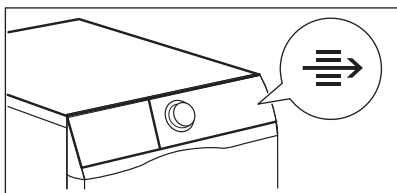

2.

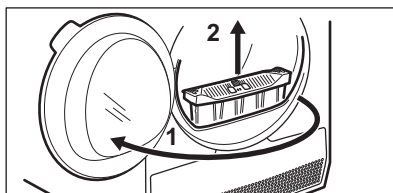

3.

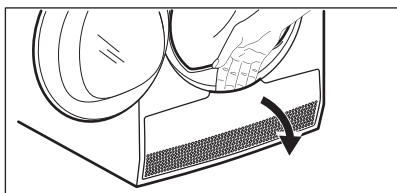

4.

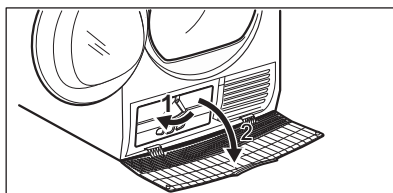

5.

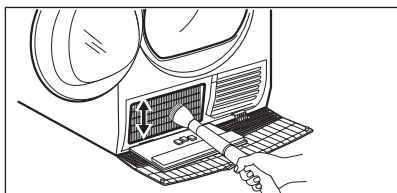

6.

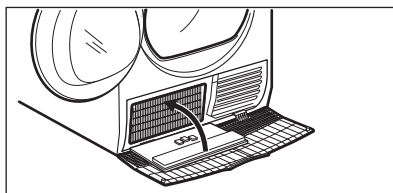

7.

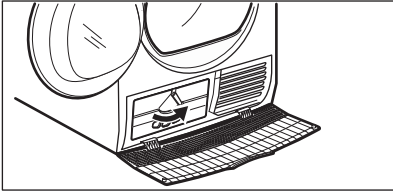

8.

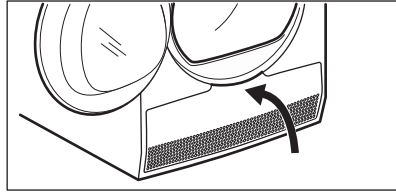

9.

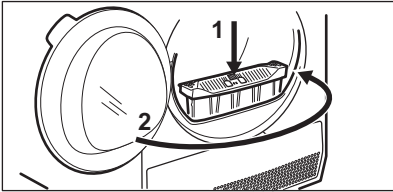

CAUTION! Do not touch the metal surface with bare hands. Risk of injury. Wear protective gloves. Clean carefully to avoid damaging the metal surface.

Cleaning the drum



WARNING! Disconnect the appliance before you clean it.

Use a standard neutral soap detergent to clean the inner surface of the drum and drum lifters. Dry the cleaned surfaces with a soft cloth.



CAUTION! Do not use abrasive materials or steel wool to clean the drum.

Cleaning the control panel and housing

Use a standard neutral soap detergent to clean the control panel and housing.

Use a moist cloth to clean. Dry the cleaned surfaces with a soft cloth.



CAUTION! Do not use furniture cleaning agents or cleaning agents which can cause corrosion.

Cleaning the airflow slots

Use a vacuum cleaner to remove fluff from the airflow slots.

TROUBLESHOOTING



WARNING! Refer to Safety chapters.

Error Codes

The appliance does not start or it stops during operation.

First try to find a solution to the problem (refer to the table). If the problem persists, contact the Authorised Service Centre.



WARNING! Deactivate the appliance before carrying out any check.

In case of major problems, the acoustic signals operate, the display shows an error code and the Start/Pause button may flash continuously:

Error code	Possible cause	Remedy
E5A	Appliance motor overloaded. Too much laundry or entrap in the drum.	The program was not completed. Remove the laundry from the drum, set the program and restart the cycle.
E97	Internal fail. No communication between electronic elements of the appliance.	The program was not finished properly or the appliance stopped too early. Switch the appliance off and on again. If the error code appears again, contact the Authorised Service Centre.
EHO	The mains supply is unstable.	When the appliance is showing EHO , please wait until main supply is stable than press start. If the appliance pause the cycle without any indication then press the cycle start. If the warning will occur check the power cord / socket integrity or main supply.

If the display shows other error codes, deactivate and activate the appliance. If the problem continues, contact the Authorised Service Centre.

In case of different problem with the tumble dryer check the table below for possible solutions.

Troubleshooting

Problem	Possible solution
You cannot activate the appliance.	Make sure that the mains plug is connected to the mains socket.
	Check fuse in fuse box (domestic installation).
The drum does not rotate.	Release the rear drum locks manually (see chapter <i>Before First Use</i>).
The program does not start.	Press Start/Pause.
	Make sure that the appliance door is closed.

Problem	Possible solution
The appliance door does not close.	Make sure that the installation of the filter is correct.
	Make sure that the laundry is not caught between the appliance door and the rubber seal.
The appliance stops during operation.	Make sure that the water container is empty. Press Start/Pause to start the program again.
	Load is too small, increase the load or use the Time Drying program.
The cycle time is too long or unsatisfactory drying result. ¹⁾	Make sure that the weight of the laundry is suitable for the duration of the program.
	Make sure that the filter is clean.
	The laundry is too wet. Spin the laundry in the washing machine again.
	Ensure that the room temperature is higher than +5°C and lower than +35°C. Optimal room temperature is 18°C to 25°C.
	Set the Time Drying or the Extra Dry program. ²⁾
The display shows — — —.	If you want to set a new program, deactivate and activate the appliance.
	Make sure that the options are suitable for the program.

¹⁾ After maximum 5 hours, the program ends automatically.

²⁾ It can happen that some area remains humid when drying big items (e.g. bed sheets).

If the drying results are not satisfactory

- The set program was incorrect.
- The filter is clogged.
- The Heat Exchanger is clogged.
- There was too much laundry in the appliance.
- The drum is dirty.
- Incorrect setting of the conductivity sensor (See chapter "*Settings - Adjustment of the remaining laundry moisture degree*" for better setting).
- The airflow slots are clogged.
- Room temperature is too low or too high (optimal room temperature 18°C to 25°C)

TECHNICAL DATA

Height x Width x Depth	850 x 596 x 638 mm (maximum 662 mm)
------------------------	-------------------------------------

Max. depth with the appliance door open	1107 mm
Max. width with the appliance door open	958 mm
Adjustable height	850 mm (+ 15 mm - feet adjustment)
Drum volume	118 l
Maximum load	8 kg
Voltage	230-240 V
Frequency	50 Hz
Total power	800 W
Type of use	Household
Permitted ambient temperature	+ 5°C to + 35°C
Level of protection against ingress of solid particles and moisture ensured by the protective cover, except where the low voltage equipment has no protection against moisture	IPX4
Gas designation	R290
Weight	0,140 kg

WARRANTY

FOR SALES IN AUSTRALIA AND NEW ZEALAND

APPLIANCE: WESTINGHOUSE DRYER

This document sets out the terms and conditions of the product warranties for Westinghouse Appliances. It is an important document. Please keep it with your proof of purchase documents in a safe place for future reference should there be a manufacturing defect in your Appliance. This warranty is in addition to other rights you may have under the Australian Consumer Law.

1. In this warranty:

- a) 'ACL' or 'Australian Consumer Law' means Schedule 2 to the Competition and Consumer Act 2010;
- b) 'Appliance' means any Electrolux product purchased by you and accompanied by this document;

- c) 'ASC' means Electrolux authorised service centres;
- d) 'Westinghouse' is the brand controlled Electrolux Home Products Pty Ltd of 163 O'Riordan Street, Mascot NSW 2020, ABN 51 004 762 341 in respect of Appliances purchased in Australia and Electrolux (NZ) Limited (collectively "Electrolux") of 3-5 Niall Burgess Road, Mount Wellington, in respect of Appliances purchased in New Zealand;
- e) 'Warranty Period' means the period specified in clause 3 of this warranty;
- f) 'you' means the purchaser of the Appliance not having purchased the Appliance for re-sale, and 'your' has a corresponding meaning.

2. **Application:** This warranty only applies to new Appliances, purchased and used in Australia or New Zealand and is in addition to (and does not exclude, restrict, or modify in any way) other rights and remedies under a law to which the Appliances or services relate, including any nonexcludable statutory guarantees in Australia and New Zealand.
 3. **Warranty Period:** Subject to these terms and conditions, this warranty continues for in Australia for a period of 24 months and in New Zealand for a period of 24 months, following the date of original purchase of the Appliance.
 4. **Repair or replace warranty:** During the Warranty Period, Electrolux or its ASC will, at no extra charge if your Appliance is readily accessible for service, without special equipment and subject to these terms and conditions, repair or replace any parts which it considers to be defective. Electrolux may, in its absolute discretion, choose whether the remedy offered for a valid warranty claim is repair or replacement. Electrolux or its ASC may use refurbished parts to repair your Appliance. You agree that any replaced Appliances or parts become the property of Electrolux.
 5. **Travel and transportation costs:** Subject to clause 7, Electrolux will bear the reasonable cost of transportation, travel and delivery of the Appliance to and from Electrolux or its ASC. Travel and transportation will be arranged by Electrolux as part of any valid warranty claim.
 6. **Proof of purchase** is required before you can make a claim under this warranty.
 7. **Exclusions:** You may not make a claim under this warranty unless the defect claimed is due to faulty or defective parts or workmanship. This warranty does not cover:
 - a) light globes, batteries, filters or similar perishable parts;
 - b) parts and Appliances not supplied by Electrolux;
 - c) cosmetic damage which does not affect the operation of the Appliance;
 - d) damage to the Appliance caused by:
 1. negligence or accident;
 2. misuse or abuse, including failure to properly maintain or service;
 3. improper, negligent or faulty servicing or repair works done by anyone other than an Electrolux authorised repairer or ASC;
 4. normal wear and tear;
 5. power surges, electrical storm damage or incorrect power supply;
 6. incomplete or improper installation;
 7. incorrect, improper or inappropriate operation;
 8. insect or vermin infestation;
 9. failure to comply with any additional instructions supplied with the Appliance;
- In addition, Electrolux is not liable under this warranty if:
- a. the Appliance has been, or Electrolux reasonably believes that the Appliance has been, used for purposes other than those for which the Appliance was intended, including where the Appliance has been used for any non-domestic purpose;
 - b. the Appliance is modified without authority from Electrolux in writing;
 - c. the Appliance's serial number or warranty seal has been removed or defaced
8. **How to claim under this warranty:** To enquire about claiming under this warranty, please follow these steps:
 - a. carefully check the operating instructions, user manual and the terms of this warranty;
 - b. have the model and serial number of the Appliance available;

- c. have the proof of purchase (e.g. an invoice) available;
- d. telephone the numbers shown below.

9. Australia: For Appliances and services provided by Electrolux in Australia: Electrolux goods come with guarantees that cannot be excluded under the Australian Consumer Law. You are entitled to a replacement or refund for a major failure and for compensation for any other reasonably foreseeable loss or damage. You are also entitled to have the Appliance repaired or replaced if the Appliance fails to be of acceptable quality and the failure does not amount to a major failure. 'Acceptable quality' and 'major failure' have the same meaning as referred to in the ACL.

10. New Zealand: For Appliances and services provided by Electrolux in New Zealand, the Appliances come with a guarantee by Electrolux pursuant to the provisions of the Consumer Guarantees Act, the Sale of Goods Act and the Fair Trading Act. Where the Appliance was purchased in New Zealand for commercial purposes the Consumer Guarantee Act does not apply.

11. Confidentiality: You accept that if you make a warranty claim, Electrolux and its agents including ASC may exchange information in relation to you to enable Electrolux to meet its obligations under this warranty.

Important Notice

Before calling for service, please ensure that the steps listed in clause 8 above have been followed.

AUSTRALIA

FOR SERVICE

or to find the address of your nearest authorised service centre in Australia
PLEASE CALL 13 13 49

For the cost of a local call

FOR SPARE PARTS

or to find the address of your nearest spare parts centre in Australia
PLEASE CALL 13 13 50

For the cost of a local call

NEW ZEALAND

FOR SERVICE

or to find the address of your nearest authorised service centre in New Zealand
PLEASE CALL 0800 10 66 10

FOR SPARE PARTS

or to find the address of your nearest state spare parts centre in New Zealand
PLEASE CALL 0800 10 66 20

WDryer_Warr_Apr20

ENVIRONMENTAL CONCERNS

Recycle materials with the symbol . Put the packaging in relevant containers to recycle it. Help protect the environment and human health by recycling waste of electrical and electronic appliances. Do

not dispose of appliances marked with the symbol  with the household waste. Return the product to your local recycling facility or contact your municipal office.

www.westinghouse.com.au